

water conservation in architecture

FINAL REPORT
NOVEMBER 2005



WITH FUNDING SUPPORT FROM:

Smart Water Fund

contents

Executive Summary ↑

Introduction ↑

Household Specific Products, Devices & Systems ↑

Bathroom ↑

Baths & Showers

Price Points For AAA Rated Taps & Shower Roses

Toilets

Laundry ↑

Washing Machines

Kitchen ↑

Kitchen Taps

Dishwashers

Rainwater Tanks & Distribution Systems ↑

Rainwater Tank Types

General Considerations

Tank Size Model

Rainwater Tank Dispersion Systems

Water Tank Customer Survey ↑

Aim

Audience

Economic Constraints - Price Points & Supply Curves

ACKNOWLEDGMENTS

CASE STUDY PROJECTS

EXECUTIVE SUMMARY

Low dam levels and permanent water restrictions made water conservation a “top of mind” topic throughout the Victorian community. Whilst not all are in favour of the impact that these measures have on their lives, the very existence of active discourse is a positive first step in emphasizing the need to save or recycle water. EME’s Smart Water Fund project was commissioned with a view to identifying, through desktop research and four demonstration projects, practical actions that can be taken to save or reduce potable water consumption in the domestic environment. The project has developed techniques to make water saving devices integral and desirable features of households in the 21st century.

The major areas that can be tackled to reduce house-hold water consumption are bathroom, laundry, kitchen and garden. This report illustrates that significant water savings are possible for small, medium and large households. For example with a nominal investment of \$450 to retrofit bathroom fittings, an existing large home will save up to one million litres of water over ten years, more than two hundred litres a day. The report also looks at the important area of water re-use through the installation of a rainwater tank and pump system to capture rainwater for diversion to toilets and the garden. More detailed information can be found in this report.

The growth of this new and discerning urban-dweller market for water storage and distribution will rely heavily on the availability of knowledgeable and helpful service, site specific solutions and an aspirational attitude towards self responsibility for conserving our precious water resource. This report summarizes the areas covered by the survey undertaken to understand the tank industry in more detail. Pricing curves have been developed to illustrate price differentials for different tank types and sizes.

An essential part of our Smart Water Fund project is demonstration. Four of our architecturally designed residential projects has show-cased water conservation and recycling. Each project appeals to a different demographic with the aim of providing aspirational examples of the future home – stylish, flexible, multi-functional, healthy and most importantly reducing the consumption of precious resources, especially water. Please refer to Case Study Section. Each of the demonstration locations are modelled to achieve at least a 60% reduction in water consumption when compared to average homes of similar size and number of occupants. All properties are having water savings monitored on an on-going basis.

The objective of this project is to manage perceptions to make environmental responsibility an essential part of “success” through association with the already-accepted criteria.

INTRODUCTION

Melbourne's water businesses, City West Water, South East Water, Yarra Valley Water and Melbourne Water, with the support of the Victorian Government established the Smart Water Fund to encourage and support innovative development of water, bio-solids recycling and water saving projects within the community.

EME group is a design firm based in Melbourne, its principle designer is Luke Middleton. EME is interested in high quality architecture that optimises the performance of buildings by recognising potential that lies in natural energies and the immediate environment. We create highly unique buildings that aim to significantly reduce the consumption of energy, saving resources, preserving our quality of air, and provide healthy environments for the occupant.

As one of the successful applicants for round one funding, EME Group was awarded a grant to incorporate water efficiencies in medium density housing within the metropolitan area at four building sites being designed by EME. Efficiencies were to be achieved by providing water efficient products and rain water recycling programs.

These demonstration sites are at:

- Wrights Terrace, Prahran, 716 m²
- St. Andrews Street, Brighton, 252 m²
- Benares Street, Mitcham, 832 m²
- Beach Road, Black Rock, 948 m²

The first part of this report relates to the "theory" and research, the second part describes case studies.

HOUSEHOLD SPECIFIC PRODUCTS, DEVICES AND SYSTEMS

The 'typical Melbourne home uses approximately 270,000 litres'¹ of water each year. The pie chart below² illustrates the percentage breakdown of water used in different areas of the house.

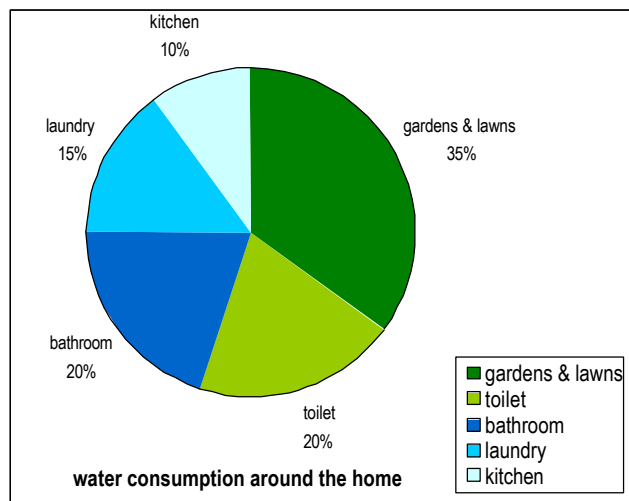

Much of this water use can be reduced by using more water efficient products. This section looks at some of these products, and their performance comparisons.

Our continued research and our four demonstration projects has enabled us to generate three models which survey the water consumption of a small, medium & large household given the comparative use of:

1. Benchmark A Rated equipment, &
2. AAA Rated equipment.³

Products, systems, and devices have been categorised into the following sub-headings:

- ↑ Bathroom
- ↑ Laundry
- ↑ Kitchen
- ↑ Tanks and Systems

¹ Figures obtained from : www.southeastwater.com.au

² op cit 3

³ Ratings are set by the National Water Conservation Labelling Scheme

To enable a comparison in consumption and cost, three models were established. These models are defined as follows:

- **Small Household** : This house is modelled on one of our actual demonstration projects (location one). It is an inner city residence with two full time occupants. The project has a 5,500L tank and its fitments, and appliances have been selected for their AAA rating. The client provided information on their water usage habits, and from this we were able to calculate the projected annual mains water usage. This information was then compared to the same household with no water tank and fitments/appliances with only an A rating.

- **Medium household** : This house is modelled on a medium sized residence with two occupants. Again, calculations were made given a water tank and AAA rated fitments/appliances, and these figures compared to the same house without a water tank and with fitments/appliances with only an A rating.

- **Large household** : This house is modelled on a large sized residence with 5 full time occupants. As above, calculations were made given a water tank and AAA rated fitments/appliances, and these figures compared to the same house without a water tank and with fitments/appliances with only an A rating.

'The National Water Conservation Rating and Labelling Scheme is a type test certification program that awards an appropriate A-rating to water efficient products that comply with all the relevant requirements of Joint Australian/New Zealand Standard AS/NZS6400 Water efficient products – Rating and labelling. The A-rating is indicated on a label which provides consumers with point of sale information on the relative water efficiency of those products. The more A's the more water efficient the product is.

The following table, obtained from the Water Services Association of Australia, outlines the different ratings.

1A (A)	2A (AA)	3A (AAA)	4A (AAAA)	5A (AAAAA)
A moderate level of water efficiency	A good level of water efficiency	A high level of water efficiency	A very high level of water efficiency	An excellent level of water efficiency

It should be noted, at present, different product groupings do not provide items that range the entire rating range. For example, showerheads are available in AAA and below, but not with a 4A, or 5A rating. The available ratings of each product type will be noted in the sections below.

BATHROOM

As shown in the pie chart above, the bathroom and toilet combined, make up the largest consumers of water on the home front (40%). Careful consideration must be given to water conservation in the design of a bathroom. We have examined shower heads, taps, spouts, and toilets, a summary follows.

BATHS, SHOWERS

Showers are a significant contributor to water consumption in the home, accounting for around 20% of a house's water consumption. Water saving showerheads/rozes will dramatically reduce household shower water consumption by up to 50%. In practical terms replacing a 16litres/minute unrated shower head with an "AAA" rated shower rose that flows at 8litres/minute will achieve an implicit 50% reduction in shower water consumption. Currently shower roses with a rating of up to AAA are available, are part of the mandatory Victorian Government 5 Star Home Scheme.

Given the three household models:

- **Small Household** : Given the Small house parameters an A Rated shower rose will use 16,380L of water per year. If a AAA rated shower rose was specified, water consumption would be reduced to 8,736L, a saving of 7,644L per year.
- **Medium Household** : In this case an A rated shower rose will use 54,600L per year. In comparison an AAA rated shower rose will use 29,120L per year, a saving of 25,480L per year.
- **Large Household** : A large house with an A rated shower rose will consume 81,900L per year. A saving of 38,220L/Yr can be achieved if an AAA rated rose is used.

PRICE POINTS FOR "AAA" RATED TAPS & SHOWER ROSES

The table below sets out our estimates of the price entry points for selected product categories. There are cheaper shower roses but we have assumed an acceptable quality level. Taps are also available with a rating of up to AAA.

Product Category	Price (Includes GST)
AAA Rated Shower Rose	\$30
AAA Tap	\$150
AAA Two Stage Tap	\$273
Flow controller	\$15

TOILETS

Toilets contribute to approximately 20% of a household's water consumption. There are a variety of toilets in existence, single flush, 6/3 dual flush, 9/4.5 dual flush. The table below shows approximate water consumption per flush for each. By using a dual flush cistern toilet water consumption can be reduced by 67%.⁴

⁴ Figures obtained from a study conducted by Caroma and published by the Department of Environment and Heritage. Refer : www.ea.gov.au/industry/corporate/eecp/case-studies/caroma-dfe.html

Cistern type	Litres per Half Flush	Litres per Full Flush
Single flush	Not available	11-13L*
11/5	5	11
9/4.5	4.5	9
6/3 Dual flush	3	6
4.5/3 dual flush	3	4.5

*Single flush toilets consume between 6-13 L depending on type. The majority are 11 L or 13L .

- **Small Household** : In a household of 1 person with a single flush toilet (11L) the yearly water consumption would be 24,000L per year. If a AAA rated 6/3 dual flush toilet was specified consumption would be reduced to 10,000L per year. A saving of 14,000L per year.
- **Medium Household** : This model is based on two occupants, given this, a single flush toilet will consume 44,000L. An AAA rated 6/3 dual flush toilet will consume 18,000L, a saving of 41%.
- **Large Household** : This model is based on a 5 person residence, a single flush toilet will consume 84,500L, where as the AAA rated 6/3 dual flush toilet will consume 34,000L. This results in a 40% saving.

It is now mandatory for new buildings to specify dual flush toilets as part of the 5 star rating scheme and this should be considered when reading the document figures and assessing the benefits of AAA rated products. Currently, toilets are available with a rating of up to AAAA. It should be noted that retro-fitting a new water efficient cistern to an existing toilet can be easily done by a plumber.

LAUNDRY

The laundry uses 15% of a homes total water consumption, or an average 40,500L. ⁵ This figure can be significantly reduced by selecting efficient appliances, washing machines are currently available with an up to 5A rating.

WASHING MACHINES

According to Queensland's Water Wise program, front loaders use up to 60% less water, 40% less energy and 50% less detergent, than top loaders. The water conserving benefits of AA and AAA rated front-loading clothes washer are significant.

There is no 'one' best washing machine to buy. The right selection of these products becomes apparent at point of purchase. Any good electrical goods store will stock AAA or 4A rated front loading washing machines. Simply look for the rating sticker and other marketing pitches emphasising the product's environmental 'friendliness'.

The following figures are based on both washing machine only and do not consider trough washes, refer tables in the appendix for detailed information:

- **Small house** : For this model, an AAA front loading washing machine will use 5,304L per year . A top loading A rated washing machine will use 17,680L per year, a difference of 12,376L.

⁵ Op cit 3

- **Medium house** : An AAA front loading washing machine will use 7,956L compared to an A rated top loader using 26,520L. In this model an AAA rated front loading machine would save 18,564L per year.
- **Large house** : In this model a top loading washing machine will use 53,040L per year, a front loading washing machine will consume 15,860L per year, a 70% saving.

KITCHEN

KITCHEN TAPS

Within the household kitchen, appliances are usually dependent on gas or electricity; however, areas such as the kitchen sink and the dishwasher account for approximately 10% of total household water consumption. In regard to the kitchen sink, the consumption of water is relative to the type of tap used. Seek to install a single gauge (flick mixer) low flow tap and a separate rainwater drinking water tap, connected to a filtrated system. Also an aerated tap can reduce water flow by 50%. Information on taps with up to a 3A rating, are available on the following site, www.wsaa.asn.au.

Also, see further information in the next section: *Tanks and Systems*.

DISHWASHERS

Today, most people consider dishwashers to be essential. Although they are perceived to consume large quantities of water, most new dishwashers are relatively efficient. According to savewater.com, "modern water efficient dishwashers can consume less water per day than hand washed dishes in the kitchen sink." The selection of a dishwasher is relative to budget, styling and efficiency requirements.

There is no 'right' dishwasher, however visit www.savewater.com for some recommendations on water efficient appliances.

Manufacturers of various water efficient appliances are subject to The National Water Conservation Rating and Labelling Scheme, where participating manufacturers must label their products with the relevant star rating, which allows consumers to make a more informed buying decision. Consumers are encouraged to look for a Star Rating on appliances and where possible choose the appliance with the higher level of water efficiency.

The following is a comparison between AAA rated dishwashers and an A rated dishwasher :-

- **Small House** : An A rated dishwasher uses a 1,747L of water per year where as an AAA rated dishwasher uses 728L per year. This is a saving of 42%.
- **Medium House** : An A rated dishwasher uses a 3,494L of water per year where as an AAA rated dishwasher uses 1,456L per year. This is a saving of 42%.
- **Large House** : An A rated dishwasher uses a 8,736L of water per year where as an AAA rated dishwasher uses 3,640L per year. This is a saving of 42%.

RAIN WATER TANKS AND DISTRIBUTION SYSTEMS

Rainwater Tanks and Systems can play an important role in household water harvesting and conservation. The tank and distribution system work together in harnessing, channeling and storing a source of water, which is independent to the local water network. Not only is this a benefit to a household budget, but it also alleviates a significant amount of pressure from the environment. Storm water is reduced and the demand for mains water is reduced. On average over 250,000L of rainwater falls on the regular Melbourne suburban block⁶. Of the 250,000L, 100,000L falls on the roof⁷. By adopting systems and tanks, which harness this water for household use, we are already saving a significant amount of water and money. Given the 'typical Melbourne house uses approximately 270,000 L of water each year⁸, it is theoretically possible to design a house which is effectively 50% self sufficient from the water network. However, in order to save more water it is important to create a system which adheres to the environmental principle of the three R's: Reduce, Recycle, Re-use.

It is important to ensure any tank or system conforms to council and building regulations. Town planning issues are subject to the council's discretion and each local councils' planning department must be consulted in regard to the aesthetic implementations of a tank. This does not necessarily mean that a permit is required. Planning issues are relative to height and width restrictions, which vary between local councils. It is advised that consumers should contact councils to familiarise themselves with the guidelines for their local council.

EME has focused most of its research on water tanks.

RAINWATER TANK TYPES

Around Melbourne there is an abundance of tank suppliers and manufactures. However, the selection of a tank ultimately comes down to the size, style, material, positioning and price. Tanks are available in sizes from as little as 100L up to well over 25,000L. Styles range from corrugated, elliptical, circular, walls, square, rectangular and open. Prices vary according to the material, size and style of the tank. A short description of studied tanks follows.

Aquaplate Tanks, Galvanised and Colour Bond Tanks

BHP has patented a protective coating that lines the internal surface of a galvanized or colour bond water tank. This coating is called Aquaplate. Aquaplate tanks have a 20-year guarantee against corrosion and perforation. They still retain either a galvanized or colour bond external appearance.

Nevertheless, they do offer a traditional rustic looking tank that may suit some urban design requirements. Most suppliers or manufacturers of these tanks also make or supply galvanized and colour bond tanks. These tanks come in a variety of shapes and sizes including, circular, oval slim line and ultra slim. Sizes from 300 litres to in excess of 40,000 litres

⁶ Fyfe, Melissa (2003) "Plugging the Drain", The Age, April 20, p.13. This assumes a 400m² block.

⁷ Ibid. This assumes a 150m² roof area.

⁸ Op cit 3

Fibre Reinforced Plastic Tanks (Fibreglass Tanks)

Tank World was the only manufacturer surveyed that offered fibreglass tanks. Fibreglass tanks are produced in a range of colours and come with a 20-year guarantee. Tank World's tanks satisfy the Australian Standard for Food Grade Fibreglass Resins AS 2634-1985. Fibreglass tanks are one of the cheaper tank options. As standard they can be submerged up to 50 per cent. If the tank is reinforced they can be fully submerged but not underground. Reinforcing doubles the cost of the tank. However, it should be noted that these tanks have limited aesthetic appeal. This is because they do not resemble a traditional water tank and they have a seam around the middle of each tank.

◆ POLYETHYLENE (PE)

PE tanks are durable, lightweight, and about the same price as a fibreglass tank. They can be supplied in various colours or black (which is cheaper) and come in a variety of styles. In the last 18 months there has been a sizeable increase in the range of tanks available for urban situations. These include oval, narrow-line and wall tanks that can fit down the side of a dwelling or used as a dividing wall in a garden/courtyard application. Most suppliers offer a 25-year warranty but this is usually a pro rata warranty that is dependent on the age of the tank.

◆ BLADDER TANKS

Bladder tanks are a fairly recent development, which allows water to be stored in a poly membrane material bladder. In design they are similar to a wine cask. The benefit is in the flexibility of the bladder, which can be placed beneath a structure or contained within a specifically designed compartment/box. The bladders come in a variety of sizes and can be custom made. This combined with their ability to be inserted into confined spaces when they are empty makes them perfect for many retrofitting applications. The bladders can also be easily emptied for storage or removal.

This type of tank is a modular system, thus by adding additional units the capacity can be increased.

◆ STEEL/METAL TANKS

Cast Iron tanks or corrugated steel tanks typically have a rustic and industrial style. They are built to last; however they are limited in colour and variety. These tanks are generally used for large commercial and industrial applications.

◆ CONCRETE TANKS

Concrete tanks are twice the cost of a conventional tank. They are usually adopted for large volume water storage, and are normally restricted in styling and colour. They are usually set on site as the weight can sometimes restrict delivery (depending on size). Concrete tanks are suitable for subterranean use. However, depending on movement, it is inevitable that the condition of the concrete shall begin to deteriorate in the long-term future. Note concrete tanks are commonly subject to local council building laws and will most likely require permits. In general these tanks are not used for domestic applications.

GENERAL CONSIDERATIONS

It is important the tank is covered to prevent water contamination, and must also contain a manhole for access to the interior if needed. Some tanks will have these features as standard. Other features commonly found in tanks are filters, inlet, and outlet valves.

Ideally water should be channelled from meshed guttering on the roof; this prevents large vegetation and litter from clogging up the filters and pipe work within the system. Another important feature of a rainwater harvesting system is the pump, which ultimately provides pressure to the water, allowing the water source to be connected to the system (that is, the taps, toilets etc).⁹

TANK SIZE MODEL

The choice of tank will ultimately come down to the design requirements of each house, the tank's water demand and its proposed application. The charts below represent the optimal tank size required to achieve a 90% abatement given our small, medium, and large house models. Each chart plots results for the average annual rainfall, a reduced 1 in 5 year & 1 in 10 year rainfall.

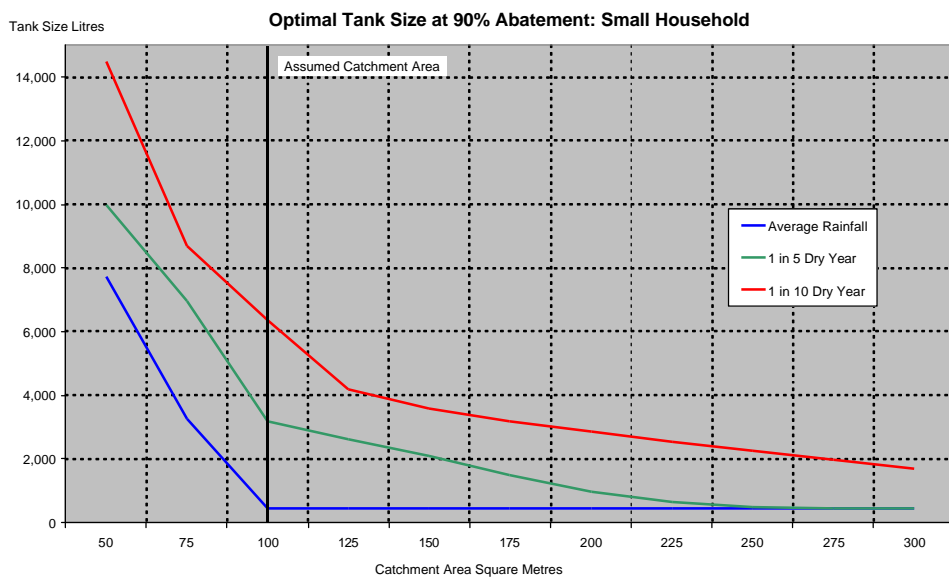

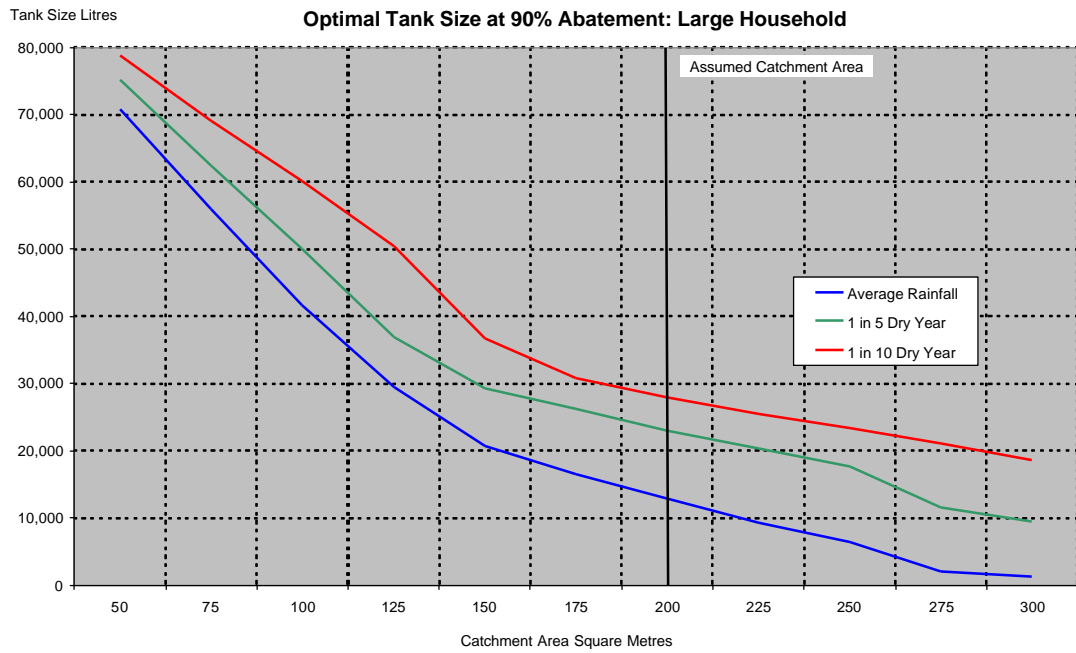
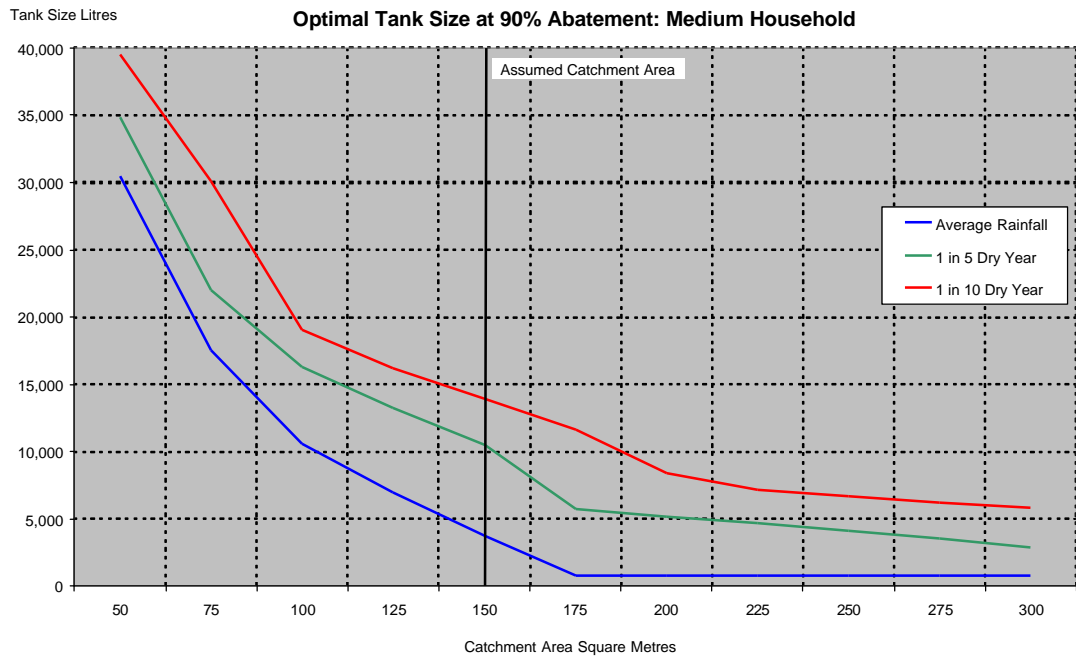

⁹ In our research it was brought to our attention that glazed tile roof catchments can result in toxic lechates such as Cadmium entering in to the tank water. No water tank guide we read mentioned this.

RAINWATER TANK DISTRIBUTION SYSTEMS

It is important to decide upon the application of the harnessed rainwater. Is it required to make a house largely independent from the water network, or is it simply to harness rainwater for gardening use, or a combination of both? The system refers to the collection and distribution of the rainwater, and includes but is not limited to, pipe work, pumps, and filters. The following section addresses the system as a whole, for specific information on pumps see below.

RAINWATER DISTRIBUTION SYSTEM : SAMPLE

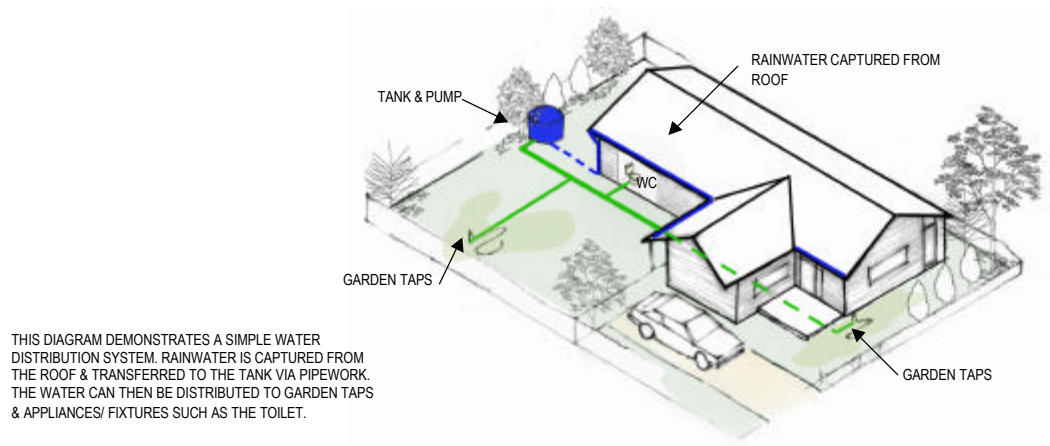

The selection of an application relates to the purpose of what the system will do in its distribution of water. Systems vary in their purpose, from the very simple to the extremely complex. The simplest systems are merely a network of piping designed to carry out a simple purpose. For example, channelling rainwater from the roof to a tank to a hose. This could be easily setup by a licensed plumber. However, advice should be sought from a tank supplier by informing them of the tank's intended application. Tank suppliers can provide advice on accessories, such as the appropriate pumps and valves, that they know function well with their products.

A pump is an integral component required for most systems, ie to move water from the tank to the point of use. A survey of pump suppliers was conducted, Onga, Orange, Davey and Clay Tech were contacted. For three tap pumps prices ranged from \$275 to \$520 and averaged \$398. Five tap pumps averaged around \$620. Warranties ranged from one year for the cheaper models to two years for the more expensive models. We would recommend to consumers that they should expect to pay over \$400 for a three-tap pressure pump. This pump is appropriate for a tank system that will supply the garden and the toilet. The more powerful five and six tank models are more appropriate for two-storey houses or homes with large garden watering requirements.

Our research has indicated that the most effective use of a rainwater tank in an urban environment involves supplying the toilet and the garden. This can abate around 50 per cent of household water consumption and involves no human contact with the water from the tank.

For a self-sufficient water source more complicated systems are available. Some systems will operate mechanically, whilst others go as far as computerised distributors and timing systems.

Water conservation is set to become the way of the future, EME hopes to encourage this and facilitate clients, the general public, and all interested parties in achieving a water conservation program in their household.

WATER TANK CUSTOMER SURVEY

AIM

The previous sections have discussed how beneficial water tanks are in water conservation, but to many people they are a concept from a bygone era or merely part of rural life. And to many people who are aware of them they appear expensive or just too hard. This information gap needs to be bridged and this project is attempting to lay the foundations of this bridge. Our major strategy involves information and making this information available to the market. We see a very large potential market for water tanks in Melbourne, however currently its growth seems impaired due to a lack of readily available and easily understood information.

We focussed on the water tanks themselves as opposed to installation issues and pumps because it was the major area of differentiation in the market. Installation can be a site-specific issue and its associated costs appear to be quite consistent across the industry. Pumps did not appear as an issue when we surveyed the market participants. Nevertheless, we did survey the major pump suppliers. The major choice issue facing consumers was the water tanks, and in particular:

- Space Constraints in Urban Environments
One of the major issues facing the urban water tank industry is space. "Where will the tank fit?" "Will it look ugly?" Etc.

Urban land is a scarce commodity with a high value. Consumers in constricted environments do not want their land taken up with a water tank. In addition to this, a water tank may spoil the visual amenity of a residence. This issue runs parallel with the aspirational attitude to water tanks that we are trying to promote. Thus we conducted detailed research and analysis of the submergibility and under grounding possibilities of each water tank. Tank manufactures have responded positively to these requirements and now provide more extensive information on their extended tank range to assist urban customers

A common method of overcoming space issues involves placing the tank under decking i.e. patios and pergolas. This is where the dimensions are important because the consumer will be constrained by the spacing of the stumps or supports. This information in conjunction with the submergibility of each tank enables the consumer to ascertain their water tank options quickly and easily.

There has also been a quick uptake by manufacturers who now offer a good range of slim-line, and ultra slim/wall tanks for very tight sites. This provides the opportunity for small inner city homes to retro-fit a tank down the side of their house and/or in the courtyard.

AUDIENCE

The target audience of the database is as follows

- ↑ Consumers that can afford to own their own home
- ↑ Builders and developers
- ↑ Architects, engineers, designers and other building industry professionals
- ↑ Building industry trades people

People that can afford to own their own home are the main target audience. Currently, many people are aware of water tanks but not aware of how affordable they are. This project aims to enhance their knowledge and ease their entry in to the market. One of the fundamental assumptions of a properly functioning competitive market is perfect information. This ensures that consumers are adequately informed to make rational decisions within the market. In creating the database we are attempting to improve the knowledge of consumers thereby enabling them to make the rational & informed decision, to implement rainwater catchment and distribution systems.

Another aim of this part of the project is to create an aspiration amongst consumers to have a water tank. That is to create the idea that a water tank is a necessary accoutrement for a responsible (and fashionable) person in Melbourne.

Builders and industry professional are also targeted because they often make the decision whether to install a water tank. They are also often the first contact point for people wanting to build a home or renovate an existing property. Therefore, in targeting this group we will also be indirectly engaging the consumers. Furthermore, those that design dwellings need to be able to access the dimensions of water tanks so that they can incorporate them in to their designs. The database will enable them to have all available products and their dimensions when designing homes.

Building trades people are targeted because they can also be the first point of call for consumers. A consumer may want to install a water tank and will possibly contact a plumber. We aim to ensure that this plumber will have access to information that will enable him or her to select the appropriate product for the consumer.

ECONOMIC CONSTRAINTS – PRICE POINT & SUPPLY CURVES

Price data was collected to ascertain price points for the tanks in order to help customers optimise their investment based on price and supply. From this data it was possible to construct supply curves for each type of tank by material. The supply curve is constructed using the average \$/KL for all of the tanks in the three major material categories (Aquaplate, fibreglass and PE).¹⁰ The number of tanks in each capacity range is also shown in the charts below. Continuous functions have also been estimated using regression analysis to produce the Cost Curves displayed on the charts. These curves illustrate how the price of tanks relates to the size of the tank.

In the following charts the price (\$) figures allow for tanks only, they do not include associated pump, foundation, or installation costs. The figures for these items were not included in the calculations as they are difficult to ascertain given their dependence on site factors, such as, distance to the tank, single or double storey buildings and soil type.

The table below summarises the results of the price point analysis for the 2,000, 5,000 and 10,000 litre capacity tanks within the four tank categories. Fibreglass and PE are both very similarly priced and represent the cheapest alternatives. They also offer a degree of submergibility, which offers more flexibility in urban applications. Within the 2,000 litre range a 100 per cent submergible tanks is over double the cost of a standard PE or fibreglass unit. In the 10,000 litre range this price difference remains at over 100 per cent. Our survey uncovered one manufacturer of 100 per cent submergible tanks within each material class (fibreglass, PE and bladder/poly membrane). Thus, it would appear that as more manufacturers enter this market as urban tank demand grows the high relative costs of 100 per cent submergibility might decrease. Discussions with manufacturers indicated that there was potential for price decreases when demand increases. Currently the major cost of manufacture associated with the bladder tanks is labour. As demand increases it will become economic to invest in capital equipment that will reduce the time required to make each bladder.

Price per KL based on initial investment

Tank Type	2,000 Litre Range	5,000 Litre Range	10,000 Litre Range
Aquaplate	\$334	\$226	\$134
Fibreglass	\$230	\$154	\$120
PE	\$232	\$173	\$122
100% Submergible	\$549	\$342	\$306

As can be seen from the above table, larger tanks cost a lot less per litre of storage. Choosing a larger tank for a rainwater harvesting installation optimises your investment. It should be noted that with careful planning and design a larger tank can be seamlessly integrated in to a building/landscape whether large or small.

The chart below displays the four estimated supply curves (the regressions from the previous charts). The additional cost of 100 per cent submergibility is quite obvious. In contrast the other three curves approach similar prices as the tank sizes increase.

As noted previously, these figures do not include costs associated with installation, excavation, or pumps. These figures can only be determined when site and building type is established.

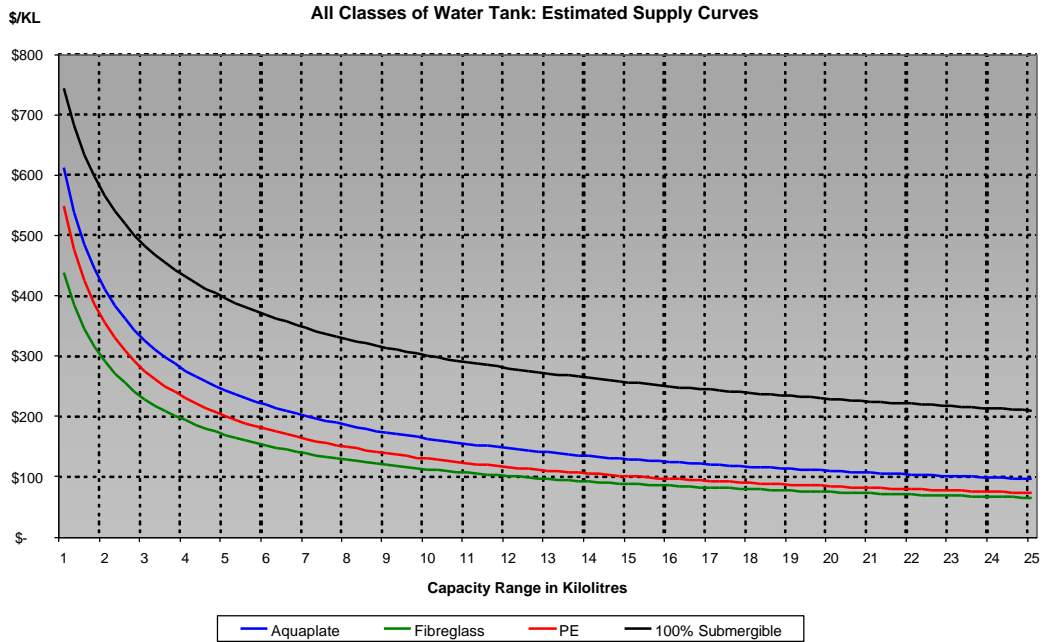

ACKNOWLEDGEMENTS

EME Group would like to thank The Smart Water Fund for their major support of this project.

In addition EME Group would like to thank all of those that have assisted us in our work. Numerous people gave up their time to assist us including; manufacturers and suppliers of water tanks and bladders; plumbing suppliers and manufacturers; designers; advanced water dispenser suppliers and manufacturers; pump manufacturers and suppliers; peak bodies and government departments; electrical appliance suppliers; plumbers and engineers; and consumers. Almost everyone we dealt with was helpful and - most importantly - very enthusiastic about reducing mains water usage. For many in the industry money was of secondary importance to assisting people in reducing water consumption.

appendix A

FINAL REPORT – CASE STUDIES

THE CASE STUDIES demonstrate how appealing architecture can be seamlessly combined with effective water harvesting infrastructure, and high quality WSUD (water sensitive urban design)

These demonstration sites are:

- Wrights Terrace, Prahran (250m2)	5500 litres
- St. Andrews Street, Brighton (4 town houses on 780m2)	20,000 litres
- Benares Street, Mitcham (720m2)	10,000 litres
- Beach Road, Black Rock (940m2)	15,000 litres

* areas indicated in brackets above are total meter square of land

Case Study House 1 - Wrights Terrace, Home Studio, Prahran

Household Type: Small

Adaptable home with integrated work studio for Melbourne fashion designer.

Occupants

2 adults

+ home fashion studio during the day

Description:

Light, airy and flexible home, 2 master bedrooms with upper level studio, spacious courtyard with timber decking

The home for Melbourne fashion designer, Faye Officer, is located in the inner Melbourne suburb of Prahran. The project merges urban context, unique spatial planning, innovative use of materials, sustainable design principles and the owner's own sense of flair and well-being.

Timber and Hebel block are the primary materials used, selected for their life-cycle, low embodied energy, ease of use, and non-toxic properties.

The building utilizes an inverse veneer construction technique. Hebel blockwork is placed internally where its excellent thermal qualities can provide the most benefit. The light lightweight timber is used externally to insulate and protect it from direct weather and extreme temperature changes.

The Hebel stone is finished in a rough render providing a cool and textured patina to walls, a complementary counterpoint to the soft grains of the timber lined floors and ceilings. The result is a contemporary palette of materials with a focus on natural beauty and healthy environment.

The interior planning challenges the static, hierarchical, and often small interiors of the surrounding workers cottages. The typical dark corridor common to this traditional building type has been re-programmed and externalised forming a theatrical light court and reflection pond.

Spaces are designed to evolve from day to night, from work to entertaining and for a fluctuating number of occupants.

In addition to its unique design, this building also features advanced energy and resource-conscious features. A 5500L water storage tank has been concealed under a timber deck courtyard. Rainwater is collected from the roof, stored in the tank and used to flush toilets and for garden irrigation. This achieves a 65% saving on mains water consumption. The building has also achieved a 5 star energy rating.



Case Study House 1 - Wrights Terrace, Home Studio, Prahran

Water Efficient Features

- 5500 litre fibreglass tank submerged under the deck
- water recycling systems
- water efficient AAA fittings
- 2 toilets dual flush 6/3litre connected to rainwater tank
- 1 sink (rated at 9 litre/min)
- 2 showers (rated at 9 litre/min)
- 2 basins (4 litres/min)
- 1 trough (rated at 9 litre/min)
- 1 washing machine (40° cotton: 56l and 4 ½ star rating)
- 1 dishwasher (AAA and 4star rating)



- 2 outdoor taps connected to rainwater tank
- drip irrigation front, back and 1st floor deck connected to rainwater tank

Other Environment Friendly Features

- 5 star energy rated
- water feature for natural cooling
- inverse veneer construction to increase internal thermal mass
- cross ventilation
- low embodied energy, recycled timbers
- natural oil finishes and minimal use of paint

Performance Measures

Annual normal usage (non-water wise)	200,750 litres
Actual annual usage (water wise)	69,030 litres
Annual savings with two adults	132,130 litres
	65% saving
Average daily water consumption	198 litres



Case Study House 1 - Wrights Terrace, Home Studio, Prahran



tank is accessed through removable panel in timber deck



reflection pond at the entrance acts as a passive cooling system throughout the warmer months.



pump and associated equipment fits neatly in to end of garden bed



Case Study House 1 - Wrights Terrace, Home Studio, Prahran

Section n- s

down pipes connect to 100mm pipe running around garden beds and in to tank



important note: height/depth of tank was determined to ensure gravity feed to overflow connected to street stormwater

Floor Plan

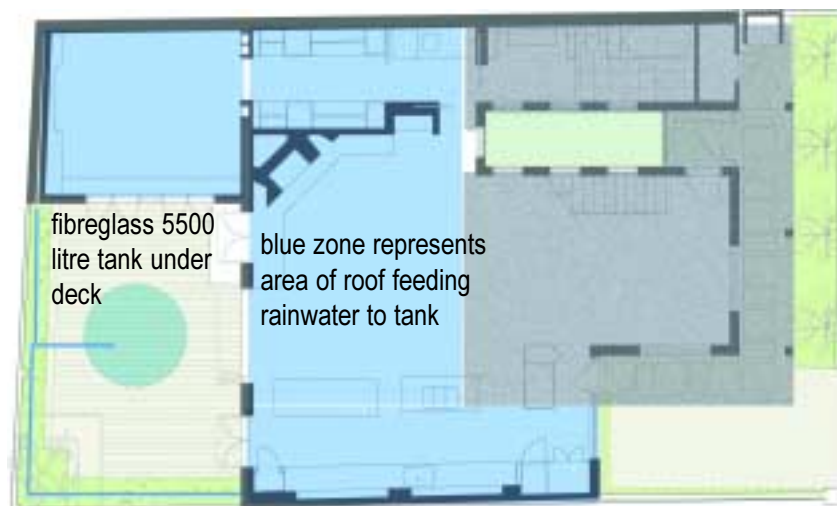

down pipes connect to 100mm pipe running around garden beds and in to tank



Case Study 2 - Eco Town Houses, Brighton

Household Type: large

Quality townhouses for Bayside purchaser

Occupants

estimated average 2.5 persons per townhouse

Description:

The site is located in the Bayside suburb of Brighton, conveniently positioned 40 metres from the commercial amenities of Bay Street, schools, transport, parks and the beaches of Port Phillip.

The client had a strong foundation in residential development, but was looking to reach a higher-end, design savvy market. Through strategic liaison with local council, the 716m² site was granted permit for the development of four new double storey town houses. This higher building-land ratio was granted by trading the inclusion of sustainable building and water saving design. EME Group's proficient knowledge of sustainable design and water conservation systems facilitated this trade.

Living spaces are located on the first floor and orientated north, maximising light and free energy provided by the sun. The roof form catches sea breezes and is sucked in to the building via theatrical light courts, providing natural cooling and ventilation. Underground water tanks store water collected from roofs, reducing reliance on mains water and relieving pressure on public stormwater systems.



Water Efficient Features

The integration of 2 x 10,000 litre rain water tanks to be shared over four townhouses. This systems has many advantages of providing stand alone systems for each town house. These include up reduced embodied



Case Study 2 - Eco Town Houses, Brighton

energy, reduced up front cost, more effective use of plant and equipment. Furthermore, it enables sharing of harvested water annually (ie when one household is on vacation, the others get the benefit and vice versa).

The consolidated system also provides a larger buffer, thereby reducing the peak loads on the public stormwater drainage system.

Rainwater from the roof is gravity feed in to a network of stormwater pipes connected to the tanks in the basement. The water runs through an atlantis filter to remove dirt, leaves and other impurities. Water collected in the basement is also pumped up in to the stormwater system. The stored rainwater supplies the toilets and irrigation to all four town houses and the irrigation to the common gardens.



1 kitchen sink (flow restricted to 9 litre/min)
1 laundry trough (flow restricted to 9 litre/min)
1 washing machine (shelf only allows frontloaders to tenants)
1 dishwasher (50° normal program: 15l)
2 toilets dual flush 6/3litre connected to rainwater tank
2 bathroom basins (flow restricted to 9 litre/min)
1 baths
2 showers (flow restricted to 9 litre/min)
1 drip irrigation front, back and 1st floor deck connected to rainwater tank
The catchment for the stormwater harvesting around 500 m2 for the four town houses.

Other Environment Friendly Features

5 star energy rating for building envelop
Cross ventilation
Thermal chimney
Double Glazing

Performance Measures (per town house)

Annual Normal (average) Usage (non-water wise)	250,937 litres
Annual target usage (water wise)	100,036 litres
Annual saving	150,901litres = 60% saving

Average daily water consumption	274 litres
---------------------------------	------------

Case Study House 2 - Eco Town Houses, Brighton



pump and associated equipment in basement



tanks located at end of basement

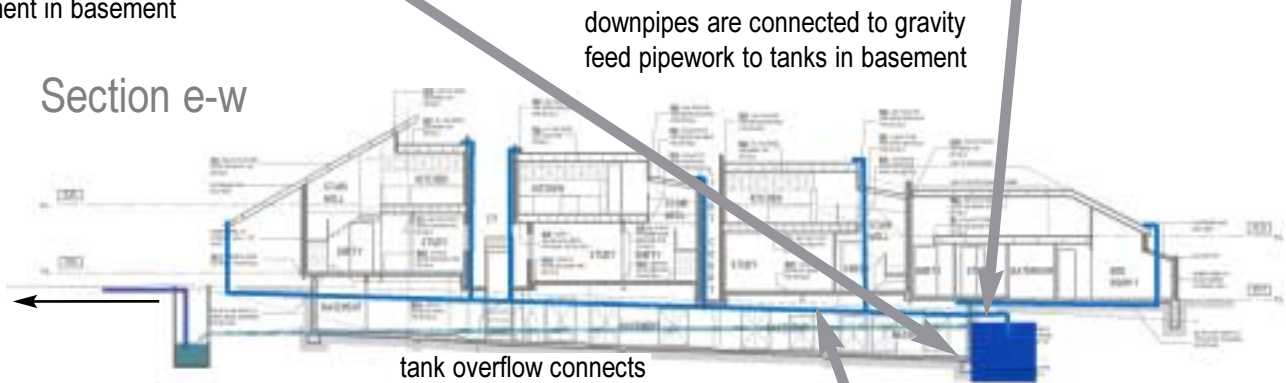

Section e-w

downpipes are connected to gravity feed pipework to tanks in basement

tank overflow connects to stormwater drain

overflow rainwater is gravity feed to sump pit located near to street frontage. water in the pit is then pumped up to street stormwater drain.



individual meters provide actual rainwater usage per townhouse



rainwater supply pipework attached to underside of ground suspended slab

Case Study 3 - japanese - australian hybrid home, mitcham

Type of Household: regular

Occupants

2 adults

+ guests for japanese tea ceremony

Description:

Designed for a Japanese-Australian couple, this home reflects the couple's distinct culturally-hybrid lifestyle.

The design reaches a balance between the beautiful sensibilities of Japanese architecture and site responsive Australian vernacular.

Multifunctional spaces connected by a spine (the Japanese inspired Roka). The building connects and wraps around a northern Japanese garden.

Master bedroom, guest bedroom, Japanese tea-room (third bedroom), study, spacious kitchen connected with living and dining pavilion.

The home incorporates a 10,000L rainwater collection tank that services the toilets and meets the gardens irrigation needs.

The clients enthusiasm for water saving is reflected in the selection of water efficient AAA rated fittings, and their daily water use routine.

The design reflects the couple's distinct culturally-hybrid lifestyle.

The harvested rain water supplies the garden irrigation, toilets and out-door taps. There are provisions so that in the future the washmachine cold water can be connected to the rainwater supply. This will further improve the effectiveness of the collected water during winter.



Case Study 3 - japanese - australian hybrid home, mitcham

Water Efficient Features

- 10,000 litre plastic tank
 - water efficient AAA fittings
 - 1 kitchen sink (9 litre/min)
 - 1 tea room sink (rated at 9 litre/min)
 - 1 laundry trough (rated at 9 litre/min)
 - 1 washing machines (provisions for connection to rainwater tank, client ensures minimum number of cycles & always use 2/3 rinsing level. Client has indicated they will substitute toploader with a front loader in the near future)
 - no dishwasher - clients have developed their own "minimal-water-usage-dishwashing-method"
 - 2 toilets dual flush 6/3litre connected to rainwater tank
 - 2 bathroom basins (rated at 9 litre/min)
 - 1 bath
 - 2 showers (rated at 9 litre/min)
 - 1 drip irrigation: front, back and side connected to rainwater tank
 - 1 japanese water garden auto-fill connected to rainwater tank
- The catchment for the stormwater harvesting is around 192 m2



japanese shower/bath opening on to water garden

Other Environment Friendly Features

- japanese water garden
- cross ventilation
- thermal chimney
- comfort plus glazing

Performance Measures

Annual Normal (average) Usage (non-water wise)	200,750 litres
Actual Annual usage (water wise)	72,000 litres
Annual saving with two adults =	128,750 litres
	= 64% saving
Average daily water consumption	197 litres



japanese tea room

Case Study 3 - japanese - australian hybrid home, mitcham



10,000 litre plastic tank

rainwater supplied to tank via this pipe. first flow diverter flushes dirty roof water prior to filling tank

overflow pipe connected to town stormwater



Tank located in unused south east corner of block

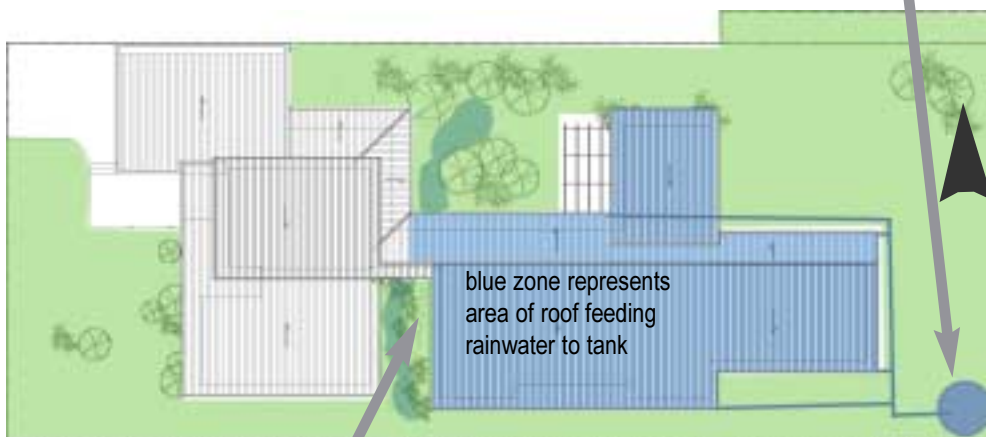

japanese water garden

Case Study House 4 - Family Resort, Black Rock

Household Type: large

Family home with resort feel.

Occupants

4 adults + 1 child

Description:

Catering for an extended family this resort like home strikes a balance between lavish design, concerns of building performance and environmental impact.

The water conservation plan includes a 15,000L tank to service the top-up pool and spa areas, irrigate the landscape and flush toilets.

This project is an excellent example of prominent high quality architecture, specifically designed for client needs while still integrating the principles of water and energy conservation.

Planned over three levels the main house features basement parking, entertaining area with pool bar, cinema, rooftop spa & bbq area. A sunken lounge on the main living area level takes in significant bay views while carefully controlling the Western sun.

Simple geometries are used on a large scale to create dramatic spaces over multiple levels. A central void and vaulted ceiling create a focal point linking the three levels, it further functions as a heat stack, allowing warm air to be drawn out and circulating cool air through the building.

Landscape

The landscape design has been inspired and informed by the project's unique location. A mixture of succulents and other salt/water tolerant plants provide the pallet. Canary palms providing shade and vertical integration with the buildings. A small patch of grass has been introduced as a formal element. It provides an interesting counter-point and carpet of green to the front garden. Primary subsurface irrigation to minimise losses due to evaporation etc.

Water Efficient Features

2 kitchen sink (flow restricted to 8 litres/min)

2 bar sink (flow restricted to 8 litres/min)

2 laundry trough (flow restricted to 8 litres/min)

2 washing machines connected to rainwater tank (cotton 40°:70l, 3½ star)

1 dishwasher (heavy: 15l, normal: 12l; double dish drawer allows half of the water and energy use)

7 toilets dual flush 6/3litre connected to rainwater tank

7 bathroom basins (flow restricted to 8 litres/min)

3 baths (9 litre/min)

5 showers (rated at 9 litre/min)

1 drip irrigation front, back and 1st floor deck connected to rainwater tank

1 pool auto-fill connected to rainwater tank

1 spa - fill connected to rainwater tank



Case Study House 4 - Family Resort, Black Rock

3 outdoor taps connected to rainwater tank

The catchment for the stormwater harvesting is around 500 m2

Other Environmental Friendly Features

North orientation of living spaces, with sun-shades to northern windows.
Minimal glazing to south. Solar cool glazing to west and east
Insulated floors, cross ventilation windows to living and bedroom spaces
Solar chimney linked to basement for natural summer cooling. In winter highlight windows capture the sun's warmth and bath spaces in light.
Solar hot water, solar hydronic heating and solar pool heating all combined. This system is very efficient, with the latest technology in solar panel collectors and heat exchangers. Further savings are made as the design of the system allows the sharing of solar energy - in autumn and spring the excess energy (not required for heating) is directed to the pool, extending the pool's usability well outside of summer.



Performance Measures

Annual Normal (average) Usage (non-water wise)	501,875 litres
Annual targeted usage (water wise)	246,375 litres
Annual saving with four adults + one child =	255,500 litres
	= 51% saving

Average daily water consumption (five people)	700 litres
---	------------



Case Study House 4 - Family Resort, Black Rock



matrix tank under front garden



view of pool from rooftop staircase

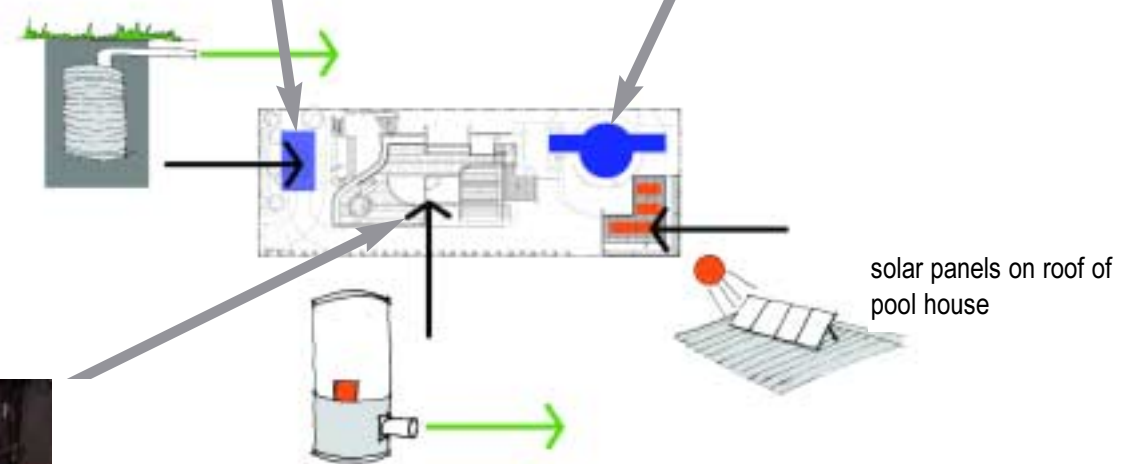

pump and associated equipment in basement plantroom



solar boiler and associated equipment in basement plantroom

Case Study House 4 - Family Resort, Black Rock

Section e-w

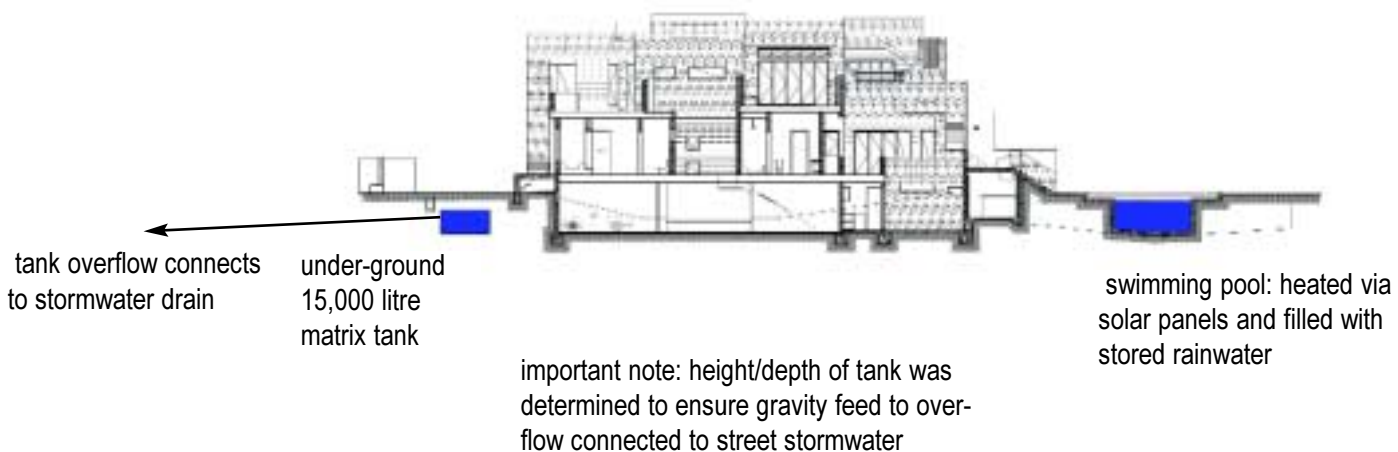

Floor Plan

