



HATLAR *group*

**CLEAN-IN-PLACE BEST PRACTICE  
GUIDELINES – Part I  
Compare CIP with Best Practice**

**For**

**Smart Water Fund**

**August 2010**

ENVIRONMENTAL PROBLEM SOLVERS



ACN: 130 123 367  
ABN: 74 719 125 480



## Glossary

Atomisation	The process by which the chemical bonds in a molecule are broken to yield separated (free) atoms
BAT	Best Available Techniques or Technologies
BOD	Biochemical Oxygen Demand. The amount of oxygen required by aerobic microorganisms to decompose the organic matter in a sample of water
Brix	Unit of measurement of the amount of soluble material (usually sugar) in a liquid
Caustic	Colloquial term for Sodium Hydroxide (NaOH) - a strongly alkaline compound that is used in manufacturing for cleaning equipment and lines
Chemical Energy	The energy in a substance that can be released by a chemical reaction
CIP	Clean-In-Place. CIP is a practice for cleaning tanks, pipelines, and process equipment by circulating water and cleaning solutions through them without dismantling the pipelines or equipment
CIP circuit	The CIP sequence designated for a particular process i.e. for allergens/colour
CIP cycle	An entire CIP sequence
CIP Set	The equipment used while performing CIP cycles on the equipment
CIP sequence	The stages in which a CIP is conducted i.e. rinse, caustic wash, rinse.
COD	Chemical Oxygen Demand. The amount of oxygen required to oxidise all the oxidisable material (organics and inorganics) in a wastewater sample measured by a laboratory test
Conductivity	The ability or power to conduct or transmit heat, electricity, or sound.
Dead Leg	Any area in a piping system where water can become stagnant and where water is not exchanged during flushing
Denaturation Point	The point at which proteins lose their tertiary structure leading to the elimination or diminishing of their original features
Drain, sewer	A pipe or drain, usually underground, used to remove water and waste matter
EDTA	Ethylenediaminetetraacetic acid, a chemical alternative to NaOH for use in CIP cleaning processes
Emulsification	The process of combining two liquids that normally do not combine easily e.g. oil and water

Eutrophication	Eutrophication, often called algal blooms, result when water bodies , such as lakes, estuaries, or slow-moving streams receive excess nutrients (particularly nitrogen and phosphorous) that stimulate excessive plant growth (algae, periphyton attached algae, and nuisance plants weeds). The subsequent decomposition of this plant material reduces dissolved oxygen in the water column which can have negative effects on other aquatic life.
First rinse	The first rinse of a CIP sequence which can also be called pre-rinse, product rinse, initial rinse and first flush
IDS	Acronym for Iminodisuccinate. A chelating agent that combines with metal ions to remove them from waste water, also called sequestrants
Kinetic Energy	The work needed to accelerate a body of a given mass from rest to its current velocity
KOH	Potassium Hydroxide
MGDA	Methylglycin diacetate
NaOH	Sodium Hydroxide
NTA	Nitrilotriacetate
Ozone	Highly reactive compound that is commonly used for bleaching substances and for killing microorganisms in air and water.
Ozonated Water	Water with ozone dissolved in it to increase its oxidizing strength
pH	A measure of the acidity or alkalinity of a solution, numerically equal to 7 for neutral solutions, increasing with increasing alkalinity and decreasing with increasing acidity
Pigging	A 'pig' is typically an engineered plug or ball made of chemically resistant plastic that fits inside the pipe and is pushed through either by the product itself or another propellant e.g. water or compressed air
Pitot Tube	A device, essentially a tube set parallel to the direction of fluid-stream movement and attached to a manometer, used to measure the total pressure of the fluid stream.
Process equipment	Equipment which uses physical or chemical methods to increase the value of a raw material or product
Product recovery	To reclaim, reuse, recycle, or purify a product.
Reagent	Chemical solution such as Caustic/Acid/Sanitiser
Reagent recovery	To reclaim, reuse, recycle, or purify reagent
Reagent solution	A mixture of reagent and water to a required concentration.

Rheology	The study of the change in form and the flow of matter, embracing elasticity, viscosity, and plasticity.
Soiling	Product and other contaminants attached to the inside of the pipes and equipment
TDS	Total Dissolved Solids, this includes organic and inorganic TDS
Thermal Energy	The energy created when the kinetic and potential energy of an object in motion is combined, often referred to as 'heat'
Turbidity	Is the cloudiness or opacity in the appearance of a liquid caused by solids, particles and other pollutants.
TW	Trade Waste. Defined as liquid wastes other than sewage generated by business and disposed of through the sewerage system
Viscosity	The property of a fluid that resists the force tending to cause the fluid to flow
Water recovery	To reclaim, reuse, recycle, or purify water
Wash liquor	A solution of water and cleaning agent used to remove remnant soil from process equipment.
WWTP	Waste Water Treatment Plant: a facility containing a series of tanks, screens, filters, and other processes by which pollutants are removed from water.

## Contents

Glossary.....	2
Disclaimer.....	7
Acknowledgements .....	7
1.0 Introduction.....	7
1.1. Purpose.....	8
1.2. Opportunity .....	8
1.3. Definition of Clean-in-Place (CIP).....	8
2. How to Use this Guideline.....	9
2.1. Other Sections of this Guideline .....	9
3. Best Practice .....	10
3.1 Brief Summary of Best Practice in CIP .....	10
3.1.1 Product removal .....	11
3.1.2 Minimise water use .....	12
3.1.3 Minimise chemical use.....	12
3.1.4 Equipment.....	14
3.1.5 Other aspects of CIP .....	14
3.2 Best Practice applied to Different Types of CIP Systems.....	15
3.2.1 Basic system with no CIP Set.....	15
3.2.2 CIP Set with Single Service tank.....	16
3.2.3 CIP Set with reagent recovery, rinse water recovery, or both .....	18
4 General CIP and Policy Assessment .....	25
4.1 CIP Constraints and critical requirements .....	25
4.2 CIP Problem Areas.....	25
4.3 CIP Schedule.....	26
4.4 Product removal.....	26
4.4.1 Pigging.....	27
4.4.2 Draining of equipment.....	27
4.4.3 Manual rinse using a hose.....	28
4.4.4 Manual scrub or dry brush.....	28
4.4.5 No product removal.....	29
4.4.6 Pushing out product with air, steam, or liquid.....	29
4.4.7 Water flush.....	29
4.4.8 Product recovery .....	30

4.5	Heat Efficiency .....	30
4.5.1	Efficient heat source .....	31
4.5.2	Heat recovery .....	31
4.6	Training of staff .....	32
4.7	Ongoing Review of CIP System .....	32

## Disclaimer

Hatlar Group Pty Ltd advises the reader that the Guidelines are to be interpreted as a guide only and that no actions or process modifications should be undertaken based on the enclosed information without seeking expert professional advice specific to the CIP system in question. Hatlar Group Pty Ltd therefore disclaims all liability for any error, loss or other consequence which may arise from a reliance on any information in these Guidelines.

## Acknowledgements

The Hatlar project team would like to thank:

- Smart Water Fund in particular Zoe Snowden for their support and funding this project
- The Steering Committee for their assistance, feedback and review of the guidelines:
  - South East Water Limited
  - City West Water Limited
  - Yarra Valley Water Limited
  - Environment Protection Authority Victoria
  - Foodservice Industry Association
  - Kraft Foods Australia
- The company partners for their participation and assistance throughout the CIP assessments:
  - Kraft Foods Australia
  - International Flavours & Fragrances Inc
  - Edlyn Foods Pty Ltd
  - Saizeriya Australia Pty Ltd
  - Chris' Greek Dips
  - Cadbury Pty Ltd
  - Fosters Group Ltd
  - Farm Pride Foods

## 1.0 Introduction

Low water levels in reservoirs and catchments as a result of changing rainfall patterns create a challenge that affects businesses today and will continue to drive business decisions into the future. Maximising the efficiency of water use both domestically and in industry has become a focus of water authorities and the community in general.

All sources of water are now the subject of intensive investigation as water authorities strive to secure water supplies into the future. As pressure to maximise the reuse of water discharged from centralised treatment plants increases, salt levels and particularly sodium loads in the treated waste water become critical as they limit reuse options. Cleaning processes in the food and beverage industry are critical to the safe production of quality products but many current cleaning practises were developed without consideration of downstream effects and as a result use large quantities of water and/or result in the discharge of high salt loads and particularly sodium salts.

These guidelines have been developed to provide information on the methods available to minimise water and chemical use in Clean in Place (CIP) in the food and beverage industry as part of a strategy to encourage industry to prioritise resource efficiency in the production process.

Within the food processing industry, cleaning systems are a significant contributor to potable water demand, chemical usage and trade waste discharge. While automated CIP systems are more efficient than manual washing systems, they are often poorly understood by those operating them and as a result are operated below standard. Typically it is possible to reduce water use, chemical demand and trade waste load from these systems by 30-50% through process optimisation, product scheduling and improvements to the CIP system. Often a substantial improvement can be obtained by simple, cost effective management and operational controls. In other circumstances more sophisticated and innovative techniques will be required to minimise water and reagent use and waste water generation.

The Best Practice Guide is a practical tool to provide food manufacturing businesses, irrespective of size, with cost effective techniques for improving the management and operation of CIP cleaning systems.

### **1.1.Purpose**

This Guideline is intended to be a practical handbook on how to optimise your CIP system. It will identify and discuss world's best practice in Clean-In-Place systems, and provide practical steps to assess your own CIP system and implement best practice.

These guidelines are aimed at shift supervisors, team leaders and senior management where companies use Clean-In-Place as part of their cleaning process.

### **1.2.Opportunity**

Use this Guideline to produce a strategy for optimising your CIP system. By assessing your own CIP system, you will generate a list of practical actions that your manufacturing company can implement to have best practice in your CIP systems. This potentially not only saves water and reagents but can result in substantial savings in labour and energy and improve overall productivity.

By implementing these guidelines you can save money. Experience has shown that businesses that optimise their CIP systems can save a minimum of 30% of the cost of water used in cleaning and in some systems this can be as high as 60%. Similar savings are available in trade waste costs through volume reductions and by reducing organic loads. Substantial savings are also available through optimising the use of cleaning chemicals, maximising energy efficiency and reduced labour and maintenance costs. It is not unrealistic to expect financial savings equal to 30% - 50% of the money spent on the CIP process

A suggested template for this list of actions can be found in Appendix 1.

### **1.3.Definition of Clean-in-Place (CIP)**

For this Guideline, CIP is defined as:



*'The process of cleaning the inside of processing equipment without removing parts or dismantling the equipment'.*

There are different opinions expressed in the literature about whether 'CIP' relates only to fully automated systems, or includes manual processes. As many manual and semi-automated systems are used in the food and beverage industry in Australia for the purposes of this Guideline, 'CIP' will include systems that are manual or have a manual component.

For the purposes of this Guideline, 'CIP' does not include such activities as cleaning of knives in an abattoir or floor cleaning.

## **2. How to Use this Guideline**

The actions to optimise your CIP system will come from three different sections in these Guidelines:

- An understanding of general Best Practice, and how your system compares (Section 3)
- An assessment of your general CIP Policy (Part I section 4)
- An assessment of your physical CIP systems (Part II section 1)

The implementation of the Guideline will generate a list of actions. Once you have generated this list of actions, it is worthwhile sorting them into high and low priorities, and high and low effort or cost to implement. There are often opportunities that result in significant water and cost savings that can be implemented right away with little effort or cost (e.g. simple set point changes, operator training and awareness, and production scheduling). Higher cost or effort actions may need further investigation before they can be implemented (e.g. capital projects, automating the system)

Not all changes need to be made at once. Sometimes it is best to make only one or two changes at a time so the effect of these changes can be observed and measured. Also, individual changes can be made gradually so the system's response to them can be observed.

### **2.1. Other Sections of this Guideline**

#### **Glossary**

Defines the terms we have used in this Guideline. There are many different words that are used in industry, and often the same words are used for different meanings depending on the individual company. The Glossary explains terms in the context that they are used in this Guideline to avoid confusion in interpretation. The Glossary is located before the Contents page.

#### **Case Studies (Part II section 4)**

The CIP systems of a wide range of food and beverage manufacturing companies were evaluated during the preparation of this Guideline. The CIP systems were assessed at each company, and several case studies have been included in Part II section 4.

Further Information (Part III section 1)

This section provides further information on some of the subjects discussed in the Best Practice, CIP Policy Assessment, and CIP System Assessment sections.

### 3. Best Practice

Best practice refers to: *techniques, methodologies, activities and approaches shown through operational experience to successfully achieve the desired task and which are effective at driving the highest levels of excellence in productivity, profitability, competitiveness and environmental outcomes for the business.*

The major sources for this information are:

- Best Practice as reported by the United Kingdom and European Union  
<http://www.envirowise.gov.uk> and [ftp://ftp.jrc.es/pub/eippcb/doc/fdm\\_bref\\_0806.pdf](ftp://ftp.jrc.es/pub/eippcb/doc/fdm_bref_0806.pdf)
- Studies and research in Australia  
[http://www.gpem.uq.edu.au/CleanProd/food\\_project/Food%20manual.pdf](http://www.gpem.uq.edu.au/CleanProd/food_project/Food%20manual.pdf)
- Research funded by the Smart Water Fund  
[http://www.citywestwater.com.au/business/docs/Clean\\_In\\_Place\\_Review.pdf](http://www.citywestwater.com.au/business/docs/Clean_In_Place_Review.pdf)
- The Hatlar Group's considerable experience in CIP assessment and optimisation in the food and beverage industry in Australia <http://www.hatlar.com>

Use this section to:

1. Gain an understanding of what best practice in CIP involves.
2. Compare your current system to best practice. Identify areas where there is a discrepancy between your system and best practice, and why (sometimes this is justified due to the nature of the process and resources available).
3. Generate potential actions to move your system towards best practice.

Since there are a wide range of different types of CIP systems in use in the food and beverage industry across Australia 'best practice' has also been applied to the different types of CIP systems that may be used in your factory.

#### 3.1 Brief Summary of Best Practice in CIP

CIP cleaning in relation to Best Practice is based on the following principles:

- Manage and minimise the use of water, energy and detergents.
- Select and use cleaning and disinfection agents which cause minimum harm to the environment while providing effective hygiene control.

- Ensure that the CIP systems are operated in the best way by defining the various interface boundaries by instrumentation (conductivity, pH, turbidity) rather than time or visual inspection.
- Optimise cleaning chemical types and concentration specifically for the job at hand.
- Use single use systems for small or rarely used processing equipment or where the cleaning solution becomes grossly contaminated.

The following section summarises some of the specific measures which contribute to best practice CIP management. The following measures will, if implemented, contribute to cost reductions through water and waste water savings and reduced product loss.

### 3.1.1 Product removal

Improved product removal recovers valuable product, reduces the amount of water required for removing product in the subsequent cleaning process and reduces trade waste loads and costs. Specific measures include:

- Design equipment with the capability for pigging to remove product for reuse.
- Design equipment to allow gravity draining of product for recovery.
- Remove product from processing equipment by dry or mechanical means prior to wet cleaning.
- Pre-rinsing with small quantities of water. This produces a small volume of liquid containing concentrated product. The product can, in some circumstances, be recovered and reused on or offsite or reprocessed for later inclusion in a product line. In other circumstances the liquid can be recovered for disposal.
- Use a turbidity, brix, or conductivity meter or other form of measurement to determine when product has been sufficiently removed with rinse water rather than a time-based measurement or visual observation as these can lead to over-rinsing.
- Rinse product from pipes as soon as practical after production has finished.
- Minimise amount of unneeded product left over at the end of a production run.
- In some applications, product can also be recovered from the rinse water used in CIP.
- Refer Product Removal section 4.4 for further details.

#### EXAMPLES:

- A flavour manufacturer uses a dedicated broom to sweep out the inside of powder blenders after a production run, before wet CIP starts. This reduces the amount of rinsing required and the organic load entering the trade waste system.
- A sauce manufacturer uses pigging to push tomato paste out of the pipes after production finishes. This tomato paste is captured and either used in the next production batch or disposed of as prescribed waste which means that it is not sent to trade waste.

- In a brewery, carbonated water is used to dilute the product and also to rinse product out of equipment at the start of a CIP cycle. The carbonated water and product mixture is captured and used in the product.

### 3.1.2 Minimise water use

Methods for minimisation of water use are as follows:

- Assess water use in your factory and determine whether “fit-for-purpose” water is produced elsewhere which can be captured and reused
- Capture clean rinse water and reuse it in pre-rinse or caustic stages, or in other applications within the factory.
- Optimise rinse cycle times. Use turbidity, pH, or other types of measurement to determine when each rinse has been effective and can be stopped.
- Use water efficient spray devices.
- Use high pressure hoses to clean down the inside of tanks instead of using a fill and drain system.

#### EXAMPLES:

- A spread manufacturer uses high pressure hoses for initial wash of product storage tanks with wash water recovered to the rework tank. This effectively reduces the quantity of water required in the pre-rinse, and the wash water contains product which is concentrated again and reworked.
- A chemical manufacturing company reviewed the operation of their cleaning system which was based on boiling out of reaction vessels. The boil-out process was replaced with pressure pumps, high pressure cleaning nozzles in a CIP system which resulted in water savings of 4ML/annum. An overall reduction of 32% in water usage per unit of production was achieved.

### 3.1.3 Minimise chemical use

A common perception across all industries is that “the stronger the cleaning solution, the better”. This is not always the case, and is a common cause of excess reagent use.

Therefore consider the following:

- Automatic dosing at correct concentrations.
  - It has been shown that for a caustic solution (NaOH), the effectiveness of the clean is not increased with increasing concentration over 1%. (Weeks 2007)
  - A caustic (NaOH) concentration of 1% is usually only necessary on “cooked on” areas. Areas of non-cook such as pipelines, pumps, silos, vats can often be successfully cleaned at lower concentrations. NaOH concentrations of 0.5%-0.8% can achieve acceptable cleaning and significantly reduce reagent use.

- Automatic dosing ensures that a consistent concentration is used and because of this consistency, the concentration set point can be fine-tuned to reduce reagent use.
- There is usually a feedback loop on automatic dosing stations which continuously measures either pH or conductivity of the reagent mixing tank. Plants where the concentration of reagent in the mixing tank is not monitored can still have difficulties with reagent over dosing.
- Automatic dosing of chemicals reduces the Occupational Health and Safety (OH&S) hazards posed to the operators by handling concentrated corrosive CIP reagents.
- In a single use system, if the concentration of caustic used is 1.5% and CIP is performed 5 times per week with a wash solution of 2000 litres, then over a year this system will use 2,500 kg of caustic more than necessary for no benefit. This comes at an additional cost in caustic of around \$2000 and potential issues with trade waste with regard to Total Dissolved Solids (TDS) or Sodium (Na) loads. Note, concentrations as high as 3% were observed in use in Victorian food and beverage industries.
- Regular monitoring of concentration in reagent storage tanks.
  - If the same quantity of reagent is added to the tank for each CIP but the concentration in the tank is not checked regularly, the reagent can accumulate resulting in a very high concentration being used and a higher than needed reagent consumption.
  - Another possibility is that if the reagent mix tank is not monitored then issues like valve failure can result in substantial overdosing.
- Recovery and re-use of chemicals. Use pH and conductivity meters to assist with this. See section 3.2.3 on Reagent recovery.
- Investigate alternative chemicals to reduce sodium levels in trade waste discharge. Instead of sodium hydroxide (NaOH) consider other caustic cleaners such as Potassium Hydroxide (KOH) based or mixed with NaOH, chelating agents such as EDTA, acid cleaner substitution, and enzymes. See Part III section 1 for further information. Select and use cleaning chemicals that cause minimum harm to the environment, while still being effective cleaners.

#### EXAMPLES:

- A food manufacturer adds reagent to the process mixing tank via a dosing pump system activated for a set time. The concentrations of the cleaning reagent are checked at random intervals by Quality Assurance which may be different to optimum levels.

- A beverage manufacturer converted from a caustic based cleaning reagent to an acid based reagent achieving an equivalent hygiene status with the added benefit of the prevention of bicarbonate by-product formation in the product and a significant reduction in water usage.
- A chemical company changed from a boil-out system used to clean reaction vessels to a CIP system and saved 90% of the cleaning chemicals resulting in a TDS reduction in their trade waste of 27.9 tonnes/year.

### 3.1.4 Equipment

- High pressure equipment, such as spray balls and nozzles, need to be checked for efficiency and effectiveness. The nozzles or spray holes tend to wear over time, becoming less effective and using a larger volume of water. More information can be found at: [http://service.spray.com/web/register/view\\_lit.asp?code=TM415](http://service.spray.com/web/register/view_lit.asp?code=TM415)
- Inline measurement of turbidity, pH, brix or conductivity can be used to determine when the rinsing stages of the CIP process are complete to minimise water use.
- Ensure that the drainage from each tank matches the input to that tank. Higher input than output results in a build-up of solution at the base of the tank resulting in ineffective cleaning.
- Hoses used for cleaning should have hand operated trigger nozzles.
- Remove dead legs from the system wherever possible. Dead legs can reduce the effectiveness of the clean, and will also increase rinse times as product or reagent can become stagnant in the dead leg. For more information on dead legs, see Part III section 1.
- Ensure there is sufficient storage capacity for recovery of rinse water and reagent. Often recovery of water and reagent is limited by the available storage space.

#### EXAMPLE:

- A cordial manufacturer installed a diaphragm pump to speed up tank discharge during CIP operations to ensure that no solution remained in the base of the tanks to influence the effectiveness of the clean.

### 3.1.5 Other aspects of CIP

This covers the remaining aspects of CIP which are detailed within the guidelines and refer to:

- Regular review of CIP, a system of continuous improvement.
- Checks in place to validate CIP effectiveness.
- Training of operators.
- Minimise risks and hazards from the process. (Such as handling of chemicals, leaks, trip hazards).

- CIP system policy, review, implementation incorporated and controlled under quality systems such as ISO9000 and Hazard Analysis Critical Control Point (HACCP). See Part III section 1 for further information.

### 3.2 Best Practice applied to Different Types of CIP Systems

The different types of CIP systems can range from very basic systems where there is no separate CIP equipment and the processing equipment is used for mixing and pumping the washing solution, right through to more complex systems with rinse water recovery and reagent recovery or even reagent cleaning and reagent regeneration.

'Best practice' suggests highly automated and sophisticated cleaning equipment as the optimum. This is not always practical in the food and beverage industry, and many companies have a wide range of different CIP set ups. In this guideline, different types of CIP systems are considered and 'best practice' is applied to these different types of systems so that whatever CIP system you have, it can be optimised for water, chemical, and energy use.

The different types of CIP systems are discussed below:

*Note that these types are generic. The suggestions for best practice may not be suitable for your system due to OH&S, space, cost, product, allergens, hygiene, or other reasons. You must assess your system in terms of what is possible and appropriate within this best practise guideline.*

*A 'fill and flush' system may be required in situations when the cleaning chemical solution is 'cooked' inside the process vessel to remove burnt on product.*

There are general 'best practice' guidelines that apply to any CIP system, such as verification, which have not been addressed individually below.

#### 3.2.1 Basic system with no CIP Set

This is where the existing process equipment is used for CIP (Figure 1). This often involves filling up a process tank or cooking kettle with water (often hot) then pumping the water through the process to rinse out the remaining product. The cleaning reagent is often manually added to the refilled process tank or kettle and recirculated. Rinse water and reagent solution are directed to drain after each use rather than recovered. The best practise guide for the basic system CIP cleaning system is summarised in Figure 1.

Figure 1: Generalised Process Flow Diagram for Simple CIP System

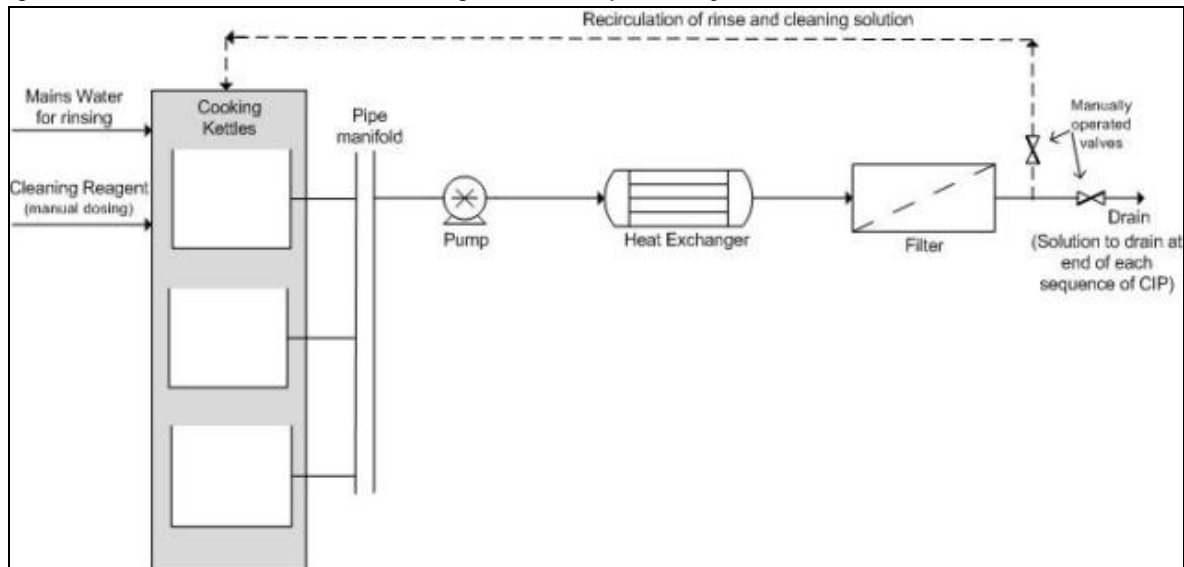

### 3.2.2 CIP Set with Single Service tank

This system uses a single CIP tank. The cleaning reagent solutions and possibly the rinse water are fed to the process equipment from this tank (Figure 2).

Figure 2: Generalised Process Flow Diagram for Single Service Tank CIP System

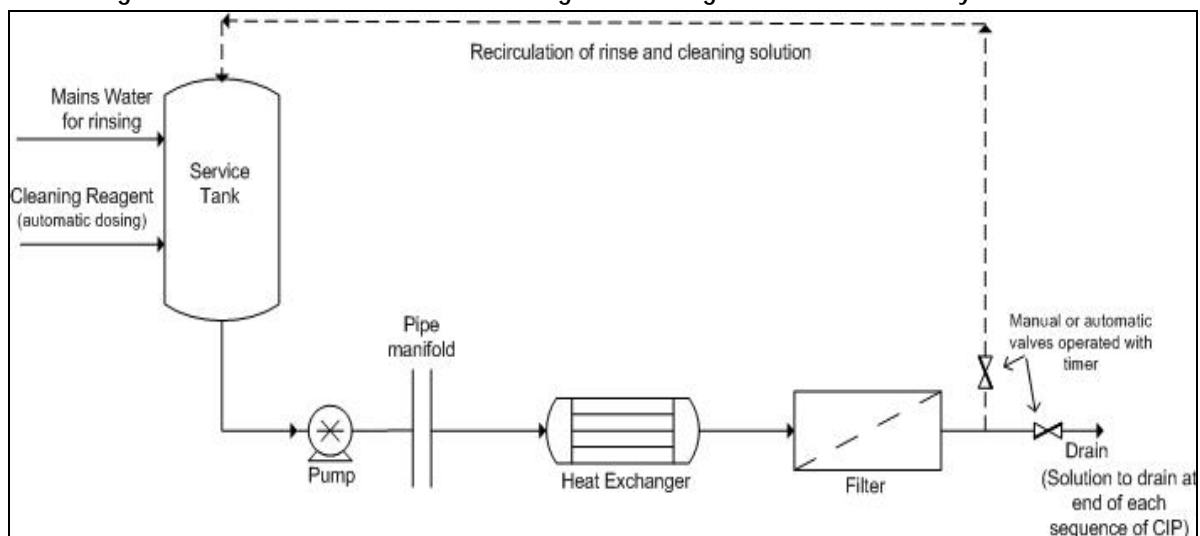

When CIP is about to begin, the tank is filled with hot water or filled with cold water then heated to the desired temperature. This is then flushed through the process equipment as a first rinse. The CIP tank is again filled with water, and a cleaning reagent (such as caustic soda) is added and the solution is mixed. This solution may be recirculated through the equipment, and eventually discharged to the drain. The CIP tank is then filled again for subsequent rinses and any other reagent or sanitising washes.

The rinse water and reagent solutions are typically discharged to drain and not recovered. The single CIP tank is a service tank rather than a dedicated mixing/storage tank. It should be noted however that in some factories the water is sourced from another separate mains water tank, which also feeds the manufacturing process as well. This mains water tank is not considered part of the CIP Set.



The best practise guide for the basic CIP cleaning system and the system with a single service tank is summarised in Table 1 below.

Table 1: Best Practice Guide for the basic CIP systems

Best Practice guide	Basic system (no CIP Set)	CIP Set Single Service tank
<b>Product Removal</b>		
Rinse out tanks with high pressure hose to remove product as this uses less water and is often more effective than filling the tank and flushing it out.	•	•
Mechanical or dry means of product removal may be suitable, enabling product recovery. See sections 3.1.1 and 4.4 on product removal for more information.	•	•
Minimise the excess amount of product left over at the end of a production run by careful planning of quantities required.	•	•
<b>Water Use</b>		
Use a “fill-recirculate–dump” system for rinsing rather than a once through system	•	•
Use the minimum quantity of water required to allow rinse and reagent recirculation	•	•
Optimise rinse cycle times if a once through system is utilised (see Part II section 1).	•	•
Investigate installing a tank for recovering final rinse water for use as an initial rinse in the next CIP cycle, or for use elsewhere in the factory.	•	•
<b>Chemical Use</b>		
Optimise the concentration of reagent used. See Section 3.1.3 for more information.	•	•
Check concentrations by measurement (pH, conductivity). This could be an in-line probe, a hand held meter or regular laboratory analysis. Regular measurement will prevent overdosing of reagent.	•	•
Have automated dosing of chemicals. This reduces safety risks associated with manual handling of chemicals significantly. The dosing system can be a simple dosing pump and control switch. Accurate dosing of chemicals ensures consistent concentration of chemical is used, and avoids the waste arising from ‘guesswork’.	•	•
Investigate installing a tank for the recovery of the reagent solution for reuse.	•	•
As the cleaning reagent is lost to drain, investigate the use of alternative chemicals that contain less sodium. Sodium cannot be removed in most Water Authority operated sewage treatment plants and becomes an issue when recycling water.	•	•

### 3.2.3 CIP Set with reagent recovery, rinse water recovery, or both

This system uses, at a minimum, a dedicated cleaning reagent mixing tank (Figure 3).

The cleaning reagent solution, but not the rinse water, is fed to the process equipment from this tank. The CIP sequence begins with a product flush and rinse with mains water which is directed to drain. This is followed by a recirculated cleaning wash. At the end of the wash sequence the cleaner remaining in the production equipment is either drained and/or chased out of the system by the addition of a mains water rinse.

The next level of complexity includes the addition of a second tank for the recovery and reuse of the final rinse water (Figure 4). This system is normally operated using conductivity control set-points or timer controls. Mains water chases the cleaning solution out of the process equipment which is then collected in the reuse water tank and used as the first rinse in the next CIP cycle.

Figure 3: Generalised Process Flow Diagram for a CIP System with Reagent Recovery

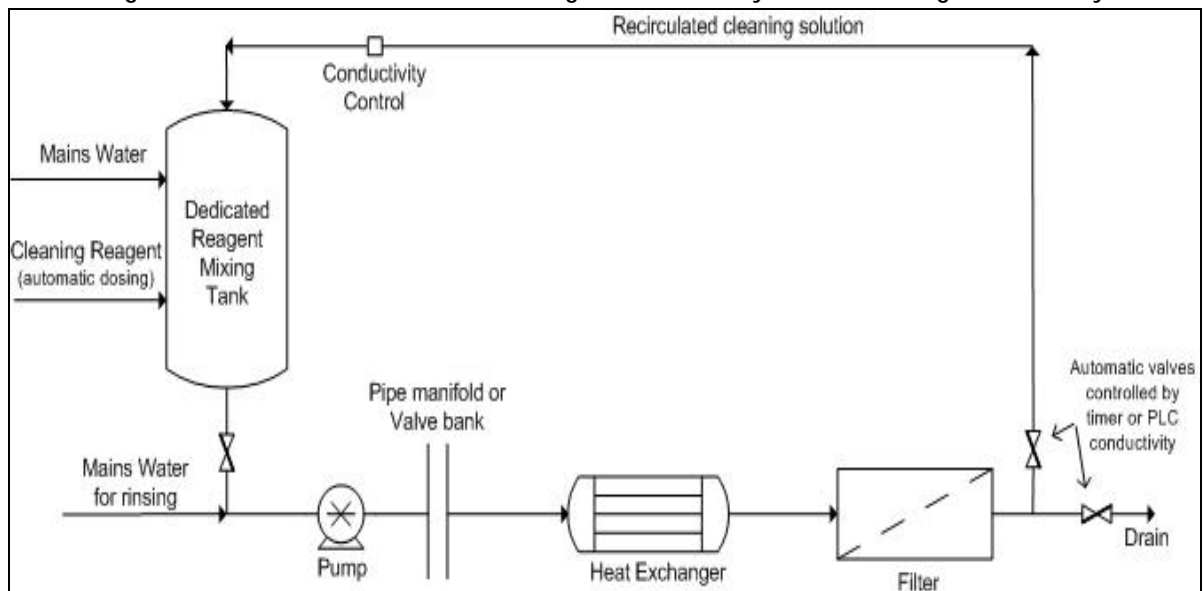
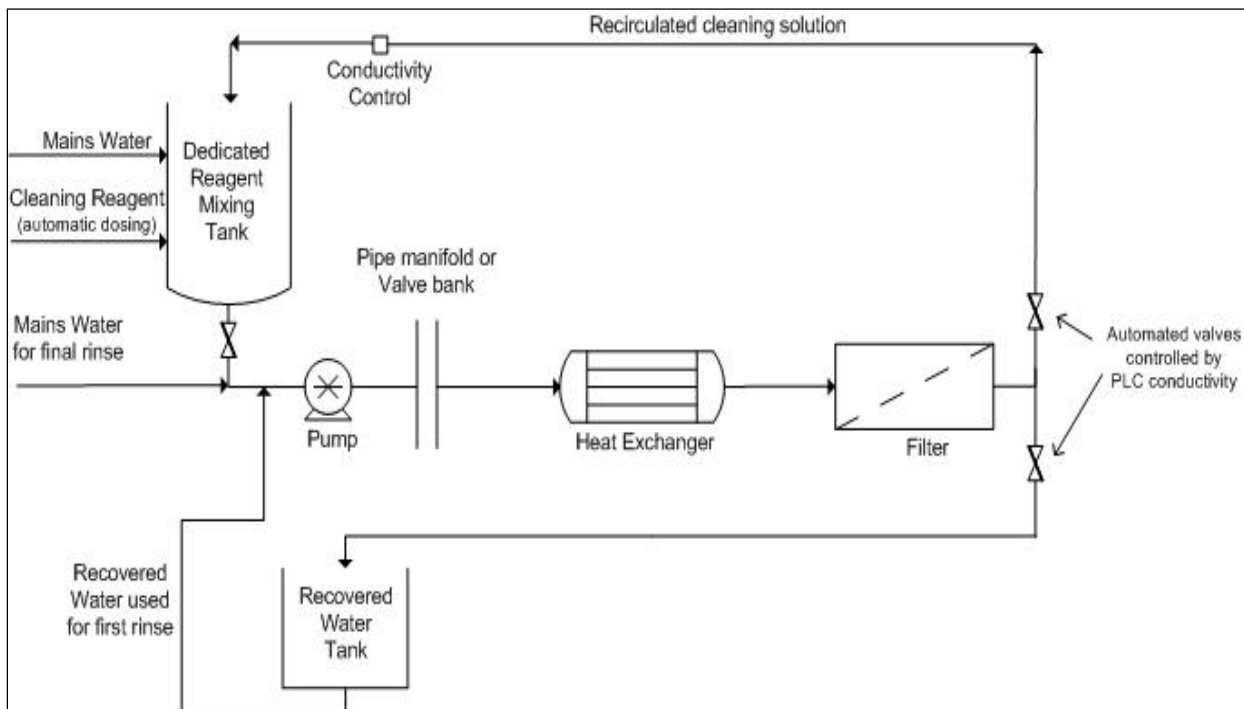

Figure 4: Generalised Process Flow Diagram a CIP System with Reagent Recovery and Rinse Recovery



Increasing levels of sophistication allow the recovery of additional reagent and maximising the reuse of reagent. These variations of system control to maximise reagent and water recovery are detailed in the following sections.

The best practice guide for CIP systems with Reagent recovery and rinse water recovery is summarised on Table 2 below.

Table 2: Best Practice Guide for CIP Systems with Reagent Recovery and/or Rinse Water Recovery

Best Practice guide	Basic Reagent Recovery (dedicated reagent mixing tank)	Basic Reagent Recovery with Rinse Water Recovery
Product Removal		
Rinse out tanks with high pressure hose to remove product. This is particularly relevant if the product is sticky as small quantities of water can be used and often the product can be recovered for reworking.	•	•
Mechanical or dry means of product removal may be suitable, enabling product recovery. See sections 3.1.1 and 4.4 on product removal for more information.	•	•
Maximise product recovery from rinse water by using instrumentation to differentiate appropriate product concentrations in the rinse water interface. Product recovered for reuse or for other uses such as stock food.	•	•

Minimise the excess amount of product left over at the end of a production run by careful planning of quantities required.	•	•
<b>Water Use</b>		
Optimise rinse cycle times (see Part II section 1) to ensure that the minimum water is used to achieve appropriate cleaning. Rinse lengths should be limited to what is actually needed. This is best done using instrument control but the rinses can also be optimised using time if based on investigation for each CIP run.	•	•
Use the minimum quantity of water required to allow rinse and reagent recirculation.	•	•
Wash and rinse cycle variation with product. Cooked on surfaces generally require higher concentrations of cleaning reagent (1%-1.2%) and longer cleaning and rinsing cycle times. Non-cooked on surfaces can be cleaned with shorter cleaning and rinse cycle times and with lower cleaning reagent strengths (0.5%-0.8%).	•	•
Install a tank for recovering final rinse water for re-use as an initial rinse in the next CIP cycle, or for use elsewhere in the factory.	•	•
Assess spray balls to ensure complete coverage, ensure spray holes are not worn, ensure sufficient pressure to reach all areas of tank, balance input and outlet flow rates to ensure water does not remain in bottom of tank, consider pulsing spray which are often more efficient and use less water.	•	•
<b>Chemical Use</b>		
Optimise the concentration of reagent used. See Section 3.1.3 for more information.	•	•
Check concentrations by measurement (pH, conductivity). This could be an in-line probe, a hand held meter or regular laboratory analysis. Regular measurement will prevent overdosing of reagent.	•	•
Have automated dosing of chemicals. This reduces safety risks associated with manual handling of chemicals significantly. The dosing system can be a simple dosing pump and control switch. Accurate dosing of chemicals ensures consistent concentration of chemical is used, and avoids the waste arising from 'guesswork'.	•	•
Installing a tank for the recovery of the reagent solution for reuse.	•	•
Maximum reagent recovered making set points as low as possible. Best case to recover all caustic in rinse water and dewater reagent solution to re-concentrate reagent (Typical process using evaporation/membranes)	•	•

Install filtration to remove soil from cleaning solution which negates need to dump reagent because of soil and maximises the reuse of the reagent	•	•
As the cleaning reagent is lost to drain, investigate the use of alternative chemicals that contain less sodium. Sodium cannot be removed at most Water Authority operated sewage treatment plants and becomes an issue when recycling water. Combined sodium and potassium based hydroxides clean cooked on surfaces just as well but reduce sodium load in waste water. Other cleaners such as enzymes/chelating/complexing/acid could be suitable for non-cooked on areas.	•	•

### 3.2.3.1 Rinse water recovery

The final rinse water is designed to remove the cleaning reagent from the production system and is in most circumstances relatively clean. It usually contains some residual cleaning reagent, and can be captured and re-used provided that it is of a quality that is 'fit for purpose' for the intended use. Often the final rinse water is used for the first rinse of the next CIP cycle. The water used in the first rinse often does not necessarily have to be mains water quality as it is simply removing the residual product from the equipment. If there is a small amount of reagent present it is unlikely to affect the effectiveness of the rinse: it is actually likely to improve product removal. This of course does not apply where the product is recovered from the initial rinse. In these cases, the initial rinse can be split into two steps: The first rinse with mains water which removes the bulk of the product, enabling the product to be recovered from this rinse, and the second part is a rinse with recovered water to flush out the system more completely.

**EXAMPLE:** A beer manufacturer uses this approach. In some parts of the process, the first rinse has two steps: first, a flush through with carbonated water to remove product. This product/carbonated water mixture is captured into the product tank. (Carbonated water is used to dilute the product where necessary). Then the next phase of the rinse uses recovered water, which is sent to drain.

The beer manufacturer sets up their CIP systems so that the amount of water used in the final rinse is roughly equal to the amount of water required for the first rinse. This way, all rinse water is used twice in CIP, and no extra water is needed, or wasted by having unbalanced first and final rinses.

Another approach to balancing the volume of first rinse and final rinse water is to have a central water recovery tank that holds all the recovered water from all the different lines in the factory. All initial rinse water is then drawn from this central tank. The water use is balanced out over all the CIP cycles throughout the whole factory.

**EXAMPLE:** A food manufacturer installed a new CIP system for use in their vegetable cooking production process which included a 30,000 litre recovered water tank which enabled the recovery and reuse of all caustic rinse water from the factory.

### 3.2.3.2 Reagent recovery

Reagent can be recovered at different levels of effectiveness.

### Level 1: Recovery of reagent into reagent storage tank

The basic commonly installed reagent recovery process (Figure 3) will recover around 80% of reagent solution for each CIP cycle. Reagent solution is recirculated throughout the process equipment and back into the reagent tank. When the cleaning stage is complete, most of the reagent solution is returned to the reagent tank. However, the reagent solution that remains in the process equipment – tanks, pipes, pumps etc. is not recovered. This is either drained to floor and/or washed out to drain by the next rinse. The amount of cleaning reagent lost will vary depending on the volume retained in the individual process.

As some of the reagent solution is lost during each CIP cycle, top up of water and reagent will be required at the completion of each cycle. Depending upon the process and product being cleaned the reagent may become dirty and require replacing after several cycles, however capture and reuse of cleaning solutions still offers significant savings.

### Level 2: Further Optimisation of reagent recovery

Further optimisation of reagent recovery focuses on two aspects:

- Cleaning or filtering the reagent to give it a longer useful life, and
- Reducing the 20% lost from the process equipment.

Cleaning up the recovered reagent to extend effective reagent life

The reagent can become dirty and collect solids as it cleans the processing equipment. Passing the reagent through a filtration system can remove the solids build up and extend the life of the reagent solution. Microfiltration is normally installed and operating costs are minimised by intermittent operation. Installation of reagent filtration systems have been shown to substantially extend reagent life but an evaluation of the capital and operating costs compared to the savings in reagent is recommended for each business.

Further information on filtration of caustic solution can be found at:  
[http://www.geafiltration.com/filtration\\_library/caustic\\_recovery\\_membrane\\_filtration.pdf](http://www.geafiltration.com/filtration_library/caustic_recovery_membrane_filtration.pdf)

The following typical caustic recovery process option has been defined by GEA Process Engineering Inc. (2009):

- The dirty caustic stream or streams are collected and sent to a dirty or spent caustic storage tank.
- Whenever dirty caustic enters or exits the storage tank it should be screened to remove the large particulates. The screen size is typically about 400 microns.
- If removal of the suspended solids is desired then the dirty caustic is sent to a Microfiltration (MF) system to clarify the caustic and concentrate the suspended solids. If this quality of caustic is acceptable for reuse then there is no other processing steps.

- If removal of the dissolved solids is also desired then the clarified caustic from the MF is sent to a Nanofiltration (NF) system. The NF system purifies the clarified caustic and concentrates the dissolved contaminants.
- If the dirty caustic contains essentially no suspended solids then the MF clarification step can be by-passed and the dirty caustic sent directly to the spiral NF. This is not the usual process.
- The caustic for reuse (clarified or purified) is sent to a storage tank.

#### Reducing the approximate 20% lost from process equipment

The reagent left in the process equipment can be recovered to a water recovery tank, back into the reagent tank or a combination of both these options.

#### Recover lost reagent with rinse water into a water recovery tank

This will include the volume of reagent solution that was left in the process equipment after the reagent wash, recovered with the rinse water. The recovered rinse water can be used as the first rinse in the next CIP cycle. The total amount of reagent used is not reduced overall, as the 20% that is now recovered from the process equipment as first rinse water is sent to drain the next time it is used but the reagent is used a second time and is likely to enhance cleaning in the initial rinse. It may allow a reduction in reagent concentration in the wash cycle.

#### Recover reagent to the reagent tank

The rinse water can be used to chase out the remaining reagent into the reagent mixing tank, before the rinse water is then diverted either to drain or to a water recovery tank. This can be controlled via PLC by use of a conductivity or pH meter, a flow meter, or by a time switch. Common practice is to use conductivity control which achieves a higher degree of control.

- For control based on time and flow

Set points can be determined by trials using conductivity or pH measurements to gauge the average time/flow for the interface to come through, or by estimating the amount of water that accumulates in the pipe work.

- For control based on measurement

A conductivity or pH meter can be set up in line on the return line to the caustic tank to control the reagent recovery. Conductivity is usually chosen as the measuring probes are more robust and require less maintenance. The return flow is directed to the reagent recovery tank until the conductivity reaches a defined set point, below which the flow is diverted away from the reagent tank into the water recovery tank or to drain.

This method can reduce the amount of reagent solution lost to less than 10% (depending on the nature and characteristics of the individual process, and the set points used to control the return of reagent solution back to the recovery tank). The

remaining 10% of reagent solution is lost to drain, or used a second time with recovered rinse water then sent to drain.

The amount of reagent recovered can also be improved through the use of different control systems to divert the reagent back to the reagent tank, and the set points of these control systems. The most efficient system is to use an inline conductivity meter. The set point of the PLC determines where the rinse water is diverted to. This means that all rinse water with a conductivity greater than the set point is sent to the reagent tank, and when the conductivity drops below the set point, the rinse water is diverted to drain or to the recovered water tank. More reagent can be recovered with a lower set point. However, often the set point is determined based on the capacity available in the reagent recovery tank – the lower the conductivity set point, the greater the volume returned to the reagent recovery tank but the more dilute the reagent solution is becoming.

The concentration of the captured reagent decreases due to dilution with the rinse water. There will need to be concentrated reagent added to the reagent tank to return the solution to the required concentration.

If the entire reagent is to be recovered, then the volume of reagent solution sent back to the reagent tank after CIP will increase with every cycle. This is because the reagent solution becomes diluted as it mixes with the rinse water inside the equipment. Therefore it is not practical to capture 100% of the reagent unless there is some form of reagent regeneration. This is discussed below.

### Level 3: Regeneration of reagent

Regeneration of the reagent goes one step further than reagent recovery, and recovers almost 100% of the reagent. The reagent left in the processing equipment is chased into the reagent recovery tank with rinse water until the entire reagent is returned. However this means that there is a significant amount of rinse water also collected in the reagent recovery tank. This dilutes the reagent concentration, and also the volume of liquid in the recovery tank is larger than the original volume of reagent. Water must be removed from the reagent to increase the concentration and reduce the volume. There are two ways to do this:

Drive off excess water as vapour or steam through an evaporation process. This option is expensive due to energy costs, but may be more feasible if excess steam capacity is available. The excess rinse water is lost as steam, unless it is condensed and returned as fresh water.

Use membrane technology MF and Reverse Osmosis (RO) to separate the reagent from excess water. This will produce a fresh water stream, which can be used as initial rinse water, or elsewhere in the factory in a 'fit for purpose' application. The reagent is also filtered using microfiltration to remove solids from the reagent and prevent blocking of the RO membranes. However, this is also an expensive process, both in capital and in operating costs and a careful cost benefit analysis is required before moving forward with this option.



## 4 General CIP and Policy Assessment

This section addresses the more general aspects of your CIP system, or how your company 'does' CIP. Use this section to generate actions for improvement.

This section contains:

- CIP Constraints and critical requirements
- CIP Problem areas
- CIP Scheduling (in production and in between times)
- Product removal
- Heat recovery
- Training of staff
- Ongoing review of CIP system

### 4.1 CIP Constraints and critical requirements

Every manufacturing operation has different key requirements for CIP. In some factories, the time taken to clean is critical, as time spent in cleaning represents time lost in production. For others, it may be that microbiological contamination is the highest risk. Other key factors could be the labour involved, the health and safety aspects of the work, the removal of allergens, minimising water use, trade waste costs, or reducing load to the onsite waste water treatment plant. There can also be different priorities for different parts of the manufacturing facility.

**EXAMPLE:** At a brewery, time was the critical constraint for the fermentation equipment, but health and safety was important for the holding tank area.

It is important to identify the important constraints and requirements for your CIP system, to ensure that the CIP system continues to meet these requirements after optimisation.

### 4.2 CIP Problem Areas

Are there any problem areas in the CIP system? What areas does the CIP system need to improve? The CIP operating staff will be able to provide some insight into the weaknesses of the CIP system.

A list of potential problem areas may include:

- Chemical/reagent use
- Consistency of clean
- Contamination of product, flavour, or colour
- Dead legs in pipe work
- Health and safety issues
- Inefficient use of heat
- Labour intensive
- Leaks
- Microbial contamination
- Product specific issues (build up, burn on, un-intended reactions)
- Product waste and product recovery
- Production downtime
- Reagent dosing system

- Trade waste issues
- Water use

Once the problem areas or system weaknesses are identified, further information and potential solutions can be investigated during the CIP assessment.

### 4.3 CIP Schedule

Can cleaning needs be reviewed? Is a rinse sufficient instead of a full CIP in some situations?

CIP is usually carried out at the end of the production shift, and if the equipment sits idle for a period of time (such as over the weekend) another full CIP may be conducted prior to production starting. The equipment is essentially clean from the first CIP, so often a sanitising rinse will be sufficient to ensure the equipment meets appropriate hygiene requirements. This will save water, reagent and time.

**EXAMPLE:** A CIP is completed at the end of a production run. If the line is not used for 12 hours then full CIP is undertaken again at the start up of production. This company is investigating substituting a single sanitising rinse on start up instead of a full CIP, to save reagent and water.

Many companies consider CIP when scheduling production. Schedule products with lighter colours and flavours before products with darker colours or stronger flavours. This often saves having to complete a full CIP wash between production runs. A simple rinse may now suffice.

Schedule products in the order of:

- |                   |   |                     |
|-------------------|---|---------------------|
| Light colours     | → | Darker colours      |
| Weak flavours     | → | Strong flavours     |
| Low concentration | → | Highly concentrated |
| No allergens      | → | Allergens           |

It is good practice to schedule production runs of products that contain allergens just before a scheduled CIP. Often, equipment must undergo a full CIP after processing products containing allergens. Scheduling an allergen-containing product just before a scheduled CIP will save undertaking an extra CIP specifically for the allergen product. This also avoids the production down time incurred while the equipment is being cleaned.

### 4.4 Product removal

Product removal happens prior to CIP or is the first step in the CIP cycle. After a production run, some product remains in the tanks, pipes, and processing equipment. This product can represent a significant cost to the company – in lost profits, ingredients, as well as disposal costs. There are two aspects to consider when addressing this subject: product removal and product recovery. These two aspects are discussed further below.

It is best to remove product as soon as practical from the equipment after production has finished. If left for too long, the product may become dried on, or congealed, or suspended solids may settle out, making it more difficult to remove. Even if a full clean or CIP cannot happen right away, the product removal step should happen as quickly as reasonably possible.

Removing the residual product should be done as efficiently as possible. If the product is sticky or has a high viscosity, it can take a large volume of water to rinse it all out from the lines; therefore a mechanical means of removing product should be considered.

Several means of product removal are discussed below:

#### 4.4.1 Pigging

A plug or block of some sort (called a 'pig' or a 'rat') is propelled down the pipe line, pushing out the product in front of it. The pig can be propelled by compressed air, water, or other liquid. The pig requires open or 'full bore' pipes without sharp angles or bends in order to move successfully through the system. Some valves, such as butterfly valves, can block the pig by providing a barrier in the pipe. For these reasons, there can be limitations when installing a pigging system retrospectively to an existing production line. Pigs are not suitable for passing through tanks or filling machines, for obvious reasons, and their use is generally restricted to lengths of pipe. The pig can either be a 'Rigid' or 'Flexible' pig. The rigid pig cannot negotiate tight bends like the flexible pig. However both require the 'full bore' to pass through. Many pigging systems have sensors to verify that the pig has successfully passed through the system.

The advantage of pigging is that the valuable product can be pushed through the system undiluted, and can be captured and re-used. Many companies install a pigging system on the last part of their production line where the completed product travels. Use of a 'pig' plug is particularly effective for sticky or viscous materials such as pastes and jams.

**EXAMPLE:** At a spread manufacturer, pigging is used in pipes containing the final product. This product is recovered and used in production. The dollar value of this recovered product was substantial and justified the considerable expenditure required to modify the existing equipment to accommodate the pig.

A pigging step sometimes occurs not only for product removal, but also between each stage in the CIP sequence.

#### 4.4.2 Draining of equipment

This can be gravity or pump assisted. The length of time required to effectively drain the equipment can be determined by trial and observation, and added into the CIP cycle time by programming the Programmable Logic Controller (PLC). Draining of equipment has limited effectiveness for very viscous products and some equipment, such as flat bottomed tanks and highly baffled heat exchangers. The configuration of pipes and equipment will also influence the effectiveness of gravity draining. Watch for places where product can accumulate or where the outlet is higher than the equipment.

Often the vats and product tanks are drained through pumps which are operated by level sensors. These can often be set at levels which leave some product in the tanks because it is believed that running the pumps dry will damage them. This is only true in limited circumstances. Most pumps can operate dry without damage for a few seconds and this is all it would take to drain the last product out of the tank.

**EXAMPLE:** At a spread manufacturer, around 20 L of raw product was left in process vats each process cycle. 16 of these process vats were tanks used every 14 hours which amounts to a loss of product of around 2,000L per week. This not only reduced product yield but increased the BOD loads and the cost of trade waste.

#### **4.4.3 Manual rinse using a hose**

Using a high pressure hose to rinse product out of equipment such as tanks saves water as the product can be quickly rinsed out using much less water than flushing or filling a tank with water.

**EXAMPLE:** A spread manufacturer initially manually washes the product vats with high pressure water producing a highly concentrated solution which is recovered and reworked and then reintroduced into the product in the next production run.

A high pressure hose is especially useful for product that is stubborn and tough to remove. For more delicate machinery, or where high pressure hoses cause an aerosol which could contaminate other processes, a mains pressure hose may be more appropriate.

There are different options for the type of pressure system to deliver pressurised water: ring main or mobile pressure cleaners. Mobile pressure cleaners may not be appropriate in your facility but they are very water efficient.

It is important to wash down the equipment as soon as possible after production. This is particularly important if product is heated.

For some products it is better to use warm or cold water – such as, anything with high quantities of protein such as blood or egg products can “cook-on” to equipment if very hot water is used. General practice is to use warm water for this duty.

Note that the way water is heated in the factory is important. Some older factories use steam mixers on the cold water hose line used in wash down to produce hot water. This causes an issue as the hose ends cannot be restricted by trigger nozzles because the back pressure created is dangerous to the operator. Companies using these types of mixers should consider replacing them as they are potentially a safety issue and they result in using substantially more water.

#### **4.4.4 Manual scrub or dry brush**

The use of manual processes to remove product prior to washing with water is a good practice and can often result in substantial water savings and reduced trade waste charges resulting from less product entering the trade waste system.

#### EXAMPLES:

- In a powder blending plant, operators brush out excess powder from the powder blender after a production run, before wet cleaning begins. This same plant has reduced the number of CIP cycles required by using an inert material (such as salt or sugar) to remove traces of product between batches that have a similar flavour characteristic.
- A confectionary manufacturer uses scrapers to remove thick starch and sugar based syrups from the cooking kettles immediately after the production run which ensures that the products do not set and significantly reduces the amount of hot water required in the first rinsing sequence of the CIP.

#### 4.4.5 No product removal

In some circumstances product removal is not required and in these situations the first rinse step in a CIP is unnecessary. This could occur where the product is water therefore there is no need for an initial rinse.

#### 4.4.6 Pushing out product with air, steam, or liquid

This is sometimes used where pigging is not possible due to pipe and equipment design. Unlike pigging, its use is not limited to the type of valve or pipe work. It is usually not effective on thick or sticky products as the air/gas purge tends to blow through the product leaving it attached to the pipe walls. These processes are most commonly used with highly fluid products.

**EXAMPLE:** A brewery uses carbonated water to purge product from the lines, a spread manufacturer uses air in the receiving area to remove remaining raw product from feed lines.

#### 4.4.7 Water flush

Some products can be removed very easily using a flush of water. Consider using pulsed flushes (ie, 10 seconds on / 20 seconds off) as these have been shown to be more effective than a straight flush (Envirowise, 2008, Reducing Water use Through Cleaning-in-Place (CIP)).

Available from:

<http://www.envirowise.gov.uk/uk/Our-Services/Publications/EN894-Reducing-water-use-through-cleaning-in-place-CIP.html>

Where appropriate, use as little water as possible to flush out a product as this makes the product washing more concentrated – and therefore often easier to re-use or dispose of. If the product waste is sufficiently concentrated and it is not going to be re-used, it can be disposed of offsite as stock food for other businesses or, as a last resort, sent to a waste treatment service rather than to trade waste (there may be a cost benefit to this – it would depend on the individual circumstances).

**EXAMPLE:** A spread manufacturer finds it cost effective to send part of their waste stream offsite for land application purposes rather than to trade waste.

Turbidity sensors based on infra-red, conductivity sensors or brix meters can be used to detect the presence of product in rinse water and divert it to a collection vessel instead of

sending it to the drain. Turbidity sensors have the advantage of retaining a high degree of accuracy over an extended time. Many products will produce a conductivity signature and conductivity can be used in these cases to differentiate product concentrations in the wash water interface. Brix meters measure sugar content so can be used in specific circumstances to differentiate product concentrations in the rinse water interface. The turbidity, conductivity or brix meters can also be used to control the length of the rinse by determining when the entire product is effectively removed.

#### 4.4.8 Product recovery

Product recovery is when the product is captured and re-used either in the existing product, in a different product or exported for a beneficial use outside the factory. The word 'product' here can refer to a finished product or an intermediate product of the process, or even a raw ingredient.

Product sent down the drain represents lost profits, and in the food and beverage industry, can be a huge source of Biological Oxygen Demand (BOD), Chemical Oxygen Demand (COD), and suspended solids (SS) in the trade waste discharge. This contributes to trade waste charges from the water authority. If waste water is treated onsite in a wastewater treatment plant, this product adds a significant load, increasing the operating costs of the treatment plant.

Recovery of product for re-use in production is best practice. Where pigging is used, undiluted product can be pushed through the system and this product can be added to the next batch.

**EXAMPLE:** The product at a spread manufacturer is pigged from the lines at the end of the production batch, stored in drums, and then put back into the process.

Where product is diluted with wash water, it can be recovered and re-worked.

**EXAMPLE:** At the above spread manufacturer, the first flush through of the lines with water produces rinse water that is high in product. This is recovered using a conductivity meter to determine the concentration, and then sent to a 'low solids recovery' tank for recovery of product.

### 4.5 Heat Efficiency

There are two aspects to heat efficiency in the CIP process:

- Have an efficient heat source or method of heating. Direct steam injection is less efficient than the use of a heat exchanger or low pressure hot water boilers.
- Recover excess heat from process streams within the factory to pre-heat CIP water, or conversely recover heat from spent CIP wash water for use in another area of the manufacturing process.

#### EXAMPLES:

- An abattoir pre-heats the incoming potable water by recovering heat via a heat exchanger from the waste water prior to discharge to the sewer.
- A small cheese manufacturer recovers the heat from the spent whey to heat the new whey destined for ricotta manufacture.
- An ice-cream manufacturer recovers the heat from the water cooling system on the pasteuriser and reuses this heated water as rinse and reagent makeup in CIP in other parts of the factory.
- A chemical manufacturing company converted the boil-out cleaning process to a CIP process which reduced gas consumption by one TJ/annum. This conversion of the cleaning process also reduced cleaning time and the resultant downtime by 676 hours/year increasing production.

#### 4.5.1 Efficient heat source

Some quick tips for improving heat efficiency:

- Check that boilers are operating efficiently and steam condensate is returned. Steam traps should receive annual maintenance as poorly maintained steam traps can be a major source of lost steam.
- Where possible, insulate pipes and equipment that contain hot liquids to prevent heat loss.
- Fouling of heat exchange surfaces will reduce the rate of heat transfer.
- Service liquids can be treated to prevent scaling, corrosion and fouling.
- Clean heat transfer surfaces periodically.
- Check equipment for maintenance, and that the equipment is operating within the manufacturers recommended parameters.

#### 4.5.2 Heat recovery

Heat can be recovered from other processing streams. Often this can be achieved in two stages – with the recovered heat being used to ‘pre-heat’ the process stream, then the final temperature is reached using traditional heating methods.

**EXAMPLE:** A confectionary manufacturer that has a single CIP service tank uses direct steam injection to heat the rinse water and reagent solution. This company could consider heating up rinse water using a heat exchanger, heating coil or steam jacket instead of direct steam injection. This could provide an opportunity to use waste heat from another part of the process (if available) to reduce overall energy costs. Also, steam condensate could be recovered – conserving boiler water treatment chemicals. This could reduce energy consumption and reduce heating times (as the CIP water would be starting at a higher temperature even if it was necessary to top up the heat with a

limited amount of direct steam), increasing the turnaround time which could result in increased production.

Dairies store milk at 4°C and use milk (product) coming into the pasteuriser to cool the milk going out of the pasteuriser.

#### 4.6 Training of staff

Training of staff in the CIP system and related subjects such as allergens and water saving initiatives is an important part of maintaining best practice in your CIP system. Ongoing training of operators helps to establish a habit of best practice and creates a culture of awareness, improvement and expertise.

Operator training should be seen as a crucial factor in maintaining high standards in product quality, plant efficiency and safety. Often, the best ideas for how to improve water efficiency and resource use come from the people who work with the system every day. This only works effectively in businesses which provide a forum in which to raise these suggestions and where they feel as though their input is valued.

Training should not just cover the actual process or method of CIP. In companies where more comprehensive training is given, the operators are generally more aware of the system, of the requirements they need to meet, and why these requirements are important. They are usually willing to share their knowledge with others. These operators also tend to be more proactive in their handling of the CIP system, and are better equipped to make decisions and communicate any issues that arise during the CIP process.

Suggestions for the type of training outside the scope of CIP method includes:

- The types of allergens present, their source and effect.
- The types of chemicals used in CIP. (Example: at one company visited all the operators thought they were using an acid for CIP when in fact it was caustic soda. This could present a safety risk.)
- The cost of water, and importance of water saving.
- The effect of the reagents used in CIP on trade waste.
- The quality of water from different sources around the factory (including recovered water) and in what applications this water is 'fit for use'.

Part III section 1.6 gives more details about training.

#### 4.7 Ongoing Review of CIP System

It is best practice to have a system of ongoing review of the CIP system.

Several businesses assessed use an annual CIP verification and review. The process parameters (temperatures, concentration, flow rates and times) are checked to ensure that the PLC system is actually controlling the systems it is set up to control. At this time, the CIP requirements are also reviewed: schedules, chemicals used, and the general CIP system overall. New ways to improve the CIP system and resource use may be identified.



In large companies, CIP systems in different parts of the factory can be assessed at each yearly review. This review could also be combined with staff and operator suggestions on ways to improve the efficiency of the system. An audit of the CIP system can also be undertaken during this review, such as suggested in Part II section 1 of this guide.



HATLAR *group*

**CLEAN-IN-PLACE BEST PRACTICE  
GUIDELINES – Part II  
Evaluation of CIP**

**For**

**Smart Water Fund**

**August 2010**

ENVIRONMENTAL PROBLEM SOLVERS



ACN: 130 123 367  
ABN: 74 719 125 480



## Glossary

Atomisation	The process by which the chemical bonds in a molecule are broken to yield separated (free) atoms
BAT	Best Available Techniques or Technologies
BOD	Biochemical Oxygen Demand. The amount of oxygen required by aerobic microorganisms to decompose the organic matter in a sample of water
Brix	Unit of measurement of the amount of soluble material (usually sugar) in a liquid
Caustic	Colloquial term for Sodium Hydroxide (NaOH) - a strongly alkaline compound that is used in manufacturing for cleaning equipment and lines
Chemical Energy	The energy in a substance that can be released by a chemical reaction
CIP	Clean-In-Place. CIP is a practice for cleaning tanks, pipelines, and process equipment by circulating water and cleaning solutions through them without dismantling the pipelines or equipment
CIP circuit	The CIP sequence designated for a particular process i.e. for allergens/colour
CIP cycle	An entire CIP sequence
CIP Set	The equipment used while performing CIP cycles on the equipment
CIP sequence	The stages in which a CIP is conducted i.e. rinse, caustic wash, rinse.
COD	Chemical Oxygen Demand. The amount of oxygen required to oxidise all the oxidisable material (organics and inorganics) in a wastewater sample measured by a laboratory test
Conductivity	The ability or power to conduct or transmit heat, electricity, or sound.
Dead Leg	Any area in a piping system where water can become stagnant and where water is not exchanged during flushing
Denaturation Point	The point at which proteins lose their tertiary structure leading to the elimination or diminishing of their original features
Drain, sewer	A pipe or drain, usually underground, used to remove water and waste matter
EDTA	Ethylenediaminetetraacetic acid, a chemical alternative to NaOH for use in CIP cleaning processes
Emulsification	The process of combining two liquids that normally do not combine easily e.g. oil and water

Eutrophication	Eutrophication, often called algal blooms, result when water bodies , such as lakes, estuaries, or slow-moving streams receive excess nutrients (particularly nitrogen and phosphorous) that stimulate excessive plant growth (algae, periphyton attached algae, and nuisance plants weeds). The subsequent decomposition of this plant material reduces dissolved oxygen in the water column which can have negative effects on other aquatic life.
First rinse	The first rinse of a CIP sequence which can also be called pre-rinse, product rinse, initial rinse and first flush
IDS	Acronym for Iminodisuccinate. A chelating agent that combines with metal ions to remove them from waste water, also called sequestrants
Kinetic Energy	The work needed to accelerate a body of a given mass from rest to its current velocity
KOH	Potassium Hydroxide
MGDA	Methylglycin diacetate
NaOH	Sodium Hydroxide
NTA	Nitrilotriacetate
Ozone	Highly reactive compound that is commonly used for bleaching substances and for killing microorganisms in air and water.
Ozonated Water	Water with ozone dissolved in it to increase its oxidizing strength
pH	A measure of the acidity or alkalinity of a solution, numerically equal to 7 for neutral solutions, increasing with increasing alkalinity and decreasing with increasing acidity
Pigging	A 'pig' is typically an engineered plug or ball made of chemically resistant plastic that fits inside the pipe and is pushed through either by the product itself or another propellant e.g. water or compressed air
Pitot Tube	A device, essentially a tube set parallel to the direction of fluid-stream movement and attached to a manometer, used to measure the total pressure of the fluid stream.
Process equipment	Equipment which uses physical or chemical methods to increase the value of a raw material or product
Product recovery	To reclaim, reuse, recycle, or purify a product.
Reagent	Chemical solution such as Caustic/Acid/Sanitiser
Reagent recovery	To reclaim, reuse, recycle, or purify reagent
Reagent solution	A mixture of reagent and water to a required concentration.

Rheology	The study of the change in form and the flow of matter, embracing elasticity, viscosity, and plasticity.
Soiling	Product and other contaminants attached to the inside of the pipes and equipment
TDS	Total Dissolved Solids, this includes organic and inorganic TDS
Thermal Energy	The energy created when the kinetic and potential energy of an object in motion is combined, often referred to as 'heat'
Turbidity	Is the cloudiness or opacity in the appearance of a liquid caused by solids, particles and other pollutants.
TW	Trade Waste. Defined as liquid wastes other than sewage generated by business and disposed of through the sewerage system
Viscosity	The property of a fluid that resists the force tending to cause the fluid to flow
Water recovery	To reclaim, reuse, recycle, or purify water
Wash liquor	A solution of water and cleaning agent used to remove remnant soil from process equipment.
WWTP	Waste Water Treatment Plant: a facility containing a series of tanks, screens, filters, and other processes by which pollutants are removed from water.

## Contents

Glossary.....	2
1 Assessment of physical CIP system.....	6
Step 1: Assess volume of water used in CIP across the entire factory .....	6
Step 2: Define the CIP system/s that will be assessed.....	6
Step 3: Observe each CIP taking place .....	7
Step 4: Take measurements of wash liquor as the CIP goes through the cycle.....	10
Step 5: Analyse the CIP data.....	12
2 Implementing Best Practice into your CIP System.....	14
2.1 Summarise Potential Improvements.....	14
2.2 Identify the Savings and Cost of each Recommendation/Action Item.....	14
2.3 Identify a prioritise each action item .....	15
2.4 Progressive Implementation.....	15
3 Validation of Changes Made to CIP System .....	16
3.1 Quality systems .....	16
3.2 Food Safety Regulations .....	16
3.3 Validating changes to CIP where CIP validation procedures exist .....	16
3.4 Managing risk when no CIP validation procedure exists.....	16
3.5 Methods to validate cleaning efficiency.....	18
4 Case Studies.....	18
4.1 CIP Review at CUB (Fosters Group) .....	18
4.2 CIP Review at Saizeriya Australia .....	20
4.3 CIP Review at Edlyn Foods .....	23
4.4 CIP Review at International Flavours and Fragrances .....	24
4.5 CIP Review at Kraft Foods .....	25
4.6 CIP Review at Cadbury (Ringwood) .....	26
Appendix 1: Table of Actions and Recommendations .....	27
Appendix 2: Worked Example of CIP Assessment.....	29
Step 1: How to assess water use for CIP across the entire factory .....	29
Step 2: Define the CIP system that will be assessed.....	30
Step 3: Observe the CIP taking place .....	32
Step 4: Take Measurements of the wash liquor as the CIP goes through the cycle.....	33
Step 5: Analyse the CIP data.....	36

## 1 Assessment of physical CIP system

This section of the Guideline explains a methodology for assessing and optimising a CIP system. This method can be applied to any CIP system, regardless of what type it is, or what products are being processed in the equipment to be cleaned.

A worked example of this method can be found in Appendix 2.

### Step 1: Assess volume of water used in CIP across the entire factory

The quantity of water consumed in CIP is necessary to benchmark the business, highlight cost of water, product loss and trade waste, and be able to assess the effect of the actions that are implemented.

There are several ways to determine this:

- Use data from CIP supply water meters if available.
- Read main water meter before and after cleaning shift.
- Or work out the amount of water used in one CIP cycle and extrapolate to find annual or total volume. This can be done by finding the flow rate or volume (PLC reading, or stopwatch and bucket method, or calculating the flow from pump curves). For more information, please see Part III section 1.3.

It is important to understand how much water is actually used for CIP – food and beverage companies are often not aware, and it can be significant. Part III section 1.4.5 has more information on calculating the true cost of water.

The cost of water is not simply represented by the mains price per kilolitre (kL). There are in reality a number of elements that make up the true cost of water. Treatment, heating or cooling, and disposal are other elements.

Another cost that can be significant, and often not properly understood, is the cost for trade waste. Many companies pay a hefty bill without scrutinising the sources of the waste. In most food and beverage companies a very significant component of the trade waste cost is associated with BOD. High BOD concentrations and loads are often an indication of high product losses. An understanding of the trade waste cost can also provide justification for optimising CIP systems to reduce these costs.

Having these figures can assist in obtaining management support for CIP optimisation work.

### Step 2: Define the CIP system/s that will be assessed

Often there are many different CIP sequences that are programmed in a food and/or beverage factory. There may be more than one CIP set, and each set may service different processing lines, and even different pieces of equipment within those lines. There may be several different types of products that must be cleaned, and the cleaning requirements of each product may be different.

Each CIP process that you have is matched to a product line and/or equipment. To optimise your CIP, you need to address each CIP set and product line individually. The following steps outline the requirements to begin the optimisation process.

1. Choose one CIP process and product to observe and optimise.
2. Identify the equipment (if any) used in the CIP (this is the CIP Set) and which equipment is cleaned in the CIP cycle.
3. Draw a process diagram (flow sheet) to show the equipment and connecting pipe work. Locate the point at which the waste is sent to drain. Mark locations of instrumentation: flow meters, etc. This information may be available in the engineering department. Alternatively you may have to track the relevant pipe work and draw your own diagram. It is important to understand what components are being washed in each CIP sequence.
4. Understand the sequence of the CIP cycle: the order of the stages in the cycle, the time for each stage in the cycle, where the water or reagent is coming from, where it is disposed to, and the concentrations used for reagents. This information should be available either on specific pages on the PLC screen or by reference to the CIP installation and commissioning documents. Alternatively, your system service provider can supply this information. If you are unable to find this information by other means then the alternative is observation of the cycles and recording flow rates and time using a stop watch.

**EXAMPLE:** A CIP sequence observed in the food and beverage industry:

1. Cold rinse, 600 seconds
2. Hot rinse, 600 seconds
3. Fill caustic tank, 400 seconds
4. Caustic flush, 600 seconds
5. Caustic rinse, 400 seconds
6. Final rinse, 360 seconds
7. Rinse to drain, 600 seconds

### **Step 3: Observe each CIP taking place**

Observation of the CIP in progress can provide valuable insights into ways the system can be optimised. Samples will need to be taken at some point, so evaluate how you can do this safely and effectively.

The following is a list of questions to ask based on the experience of conducting CIP assessments.

Is the system operating according the way it is assumed to be operating?

**EXAMPLE:** At a powder blending plant, it was discovered during a CIP assessment that the reagent dosing system was not functioning so the reagent was being added manually. This resulted in ineffective contact of the reagent with the surface of the equipment, and also the incorrect reagent was being used.

1. Is there a standard operating procedure (SOP) for CIP?



2. Is the SOP being followed or has it been modified? Observe the operators.
3. Do the operators follow the CIP procedure? If not, what are the reasons?

There may be good reasons for this. Operators may have found through experience that rinse times required were less than in the SOP and have adjusted them or they may not be followed because operators have many responsibilities and certain parts of the sequence require operator intervention.

**EXAMPLE: Determining when the product water interface is reached and that these rinses may continue for longer than required just because people have their attention diverted elsewhere.**

4. Check for leaks
  - a. Is there a maintenance plan, is a log kept?
  - b. Trip hazards
5. Check for dead legs. Dead legs harbour stagnant water where contamination can accumulate. It also increases rinse times as these places are difficult to flush out. More information on dead legs in process equipment can be found in Part III section 1.2.3.
6. Chemical
  - a. Is the correct chemical being used?
  - b. At what concentration is it? At one plant visited there was no equipment to measure concentrations and consequently no-one was actually sure what concentrations were being used.
  - c. Is it being applied correctly?
  - d. Are there any potential OH&S issues with chemical handling,
  - e. If the chemical is held in a mixing tank, then the concentration should be checked.
  - f. Chemical hazards
7. Automated system
  - a. Is it working, or do operators have to manually override it?
8. Instrumentation
  - a. What instrumentation is used during the CIP system?
  - b. Is it measuring accurately? (Is it calibrated regularly)
  - c. Is it being used appropriately?
  - d. Can use of instrumentation improve the efficiency of the CIP system?
9. Product removal

- a. What method of product removal is used?
- b. Is dry removal used (if appropriate)?
- c. Is product recovered?
- d. Is recovered product used in production?
- e. Is recovered product sent to trade waste (an effect on the cost for trade waste)?
- f. Is there any aspect of the CIP waste water that is a billed parameter in trade waste (e.g. pH, heat, conductivity, BOD, and so on)?
- g. Is recovered product sent to another destination? E.g. piggery or landfill?

#### 10. Heat

- a. How is the cleaning solution being heated? Is it efficient? (e.g. direct steam injection isn't)
- b. Can waste heat from another part of the factory or CIP system be used to heat or pre-heat the CIP wash water?

EXAMPLE: At an ice cream manufacturer: cooling water from production process is then used in CIP, both the heat and water is recovered.

- c. Can heat from spent CIP rinse water or cleaning solutions be recovered and used elsewhere?

EXAMPLE: An abattoir recovers heat from the waste water prior to discharge and uses this to pre-heat the potable water used in the factory.

#### 11. Time

- a. The time taken for the total CIP (represents the amount of time of lost production)
- b. Where is most time used in the CIP process?
- c. Are there any bottle necks in the process that extend the time taken?
- d. Where do operators spend the largest portion of their time?

#### 12. What extra challenges arise from the particular product?

EXAMPLE: In a brewing process, the product contains carbon dioxide (CO<sub>2</sub>). Some of this CO<sub>2</sub> ends up in the head spaces of the process equipment. When sodium hydroxide (caustic) is used to clean the equipment, the CO<sub>2</sub> and caustic react to form sodium bicarbonate. The sodium bicarbonate crystallizes onto the interior surfaces of the equipment, where it can build up and pose a risk of contaminating the product. The caustic is also removed from solution, making it unavailable for cleaning. Carbon dioxide is removed from the process vessels prior to cleaning, by a fan at the outlet of the vessel.

- a. If your process has a sticky product – pigging may be necessary, and using hot water for the pre-rinse may aid product removal.
  - b. Most companies generally modify the system to address these challenges, usually by adding an extra step.
  - c. Heat in process – potential for burn on?
  - d. You may need to approach cleaning differently. Different chemicals used, CIP process parameters, manual clean, and so on.
13. Is there pooling of wash water in the bottom of tanks? This indicates that the outflow of water is less than the inflow of water, and the area of the vessel covered by the pooled water is not being effectively cleaned by the spray ball or jet nozzles.

**EXAMPLE:** A cordial manufacturer installed a variable speed diaphragm pump on the outlet of the holding tanks to ensure all wash and rinse water was removed as quickly as it was supplied.

14. Are the spray balls working effectively?
- a. Is the entire product removed from the tank in the initial rinse? This could be determined by visual inspection.

**EXAMPLE:** A blending manufacturer discovered during an audit of the CIP process that the product was not being removed from the lid of the blending vessel because the spray balls were ineffective.

- b. Are they checked regularly for maintenance and wear? Water will widen spray holes over time and the pressure applied to the spray ball now may be insufficient to reach all parts of the vat or container.
  - c. Does the spray reach all the internal areas of the tank? If there are baffles or mixers inside the tank there could be a ‘shadowing’ effect.
15. Is it possible to pre-clean tanks, such as with a high pressure hose and a small volume of water? This can enable more product recovery, reduce the amount of rinse time required and reduce the amount of rinse water required.

**EXAMPLE:** A confectionary manufacturer and a food manufacturer both use a manual pre-cleaning step in their cleaning process to remove hard to clean products.

16. Are caps put on the heads of filling machines to prevent loss of cleaning water during the CIP process?

#### **Step 4: Take measurements of wash liquor as the CIP goes through the cycle**

The aim of the measurements is to determine how the cleaning system is performing in each stage: whether it is effective, and also to assess if too much water or chemical is being used. In particular, the samples will help to determine:

- The effectiveness of the product removal stage
- Whether the rinse is effective

- Is the system over rinsing
- Whether the chemicals are at the correct concentration
- Are chemicals all removed after the wash cycle

If there is adequate inline measurement of any parameter, then these measurements can be observed. Otherwise it may be necessary to sample the wash liquor.

Suitable sample point:

The best place to sample is at the end of the process equipment, just before the water goes to drain or is directed back to the CIP set for recovery.

Be aware that you may come into contact with hot liquids, or chemicals. Use appropriate personal protective equipment, such as heat resistant gloves, safety glasses, appropriate clothing with long sleeves and trousers.

Sample equipment needed:

- Bottles
- Sample jug
- Stopwatch
- Notepaper and pen
- Method of measuring (pH meter, and so on)
- Gloves/suitable personal protection equipment (PPE)

Samples will be taken during each stage of the cleaning cycle, so it is important to know when each cycle stage starts and ends – you may need two people to undertake this sampling – one to watch the operators or control screen, and one to take the samples. The person at the control screen will indicate to the person taking the samples when each stage starts. There will likely be a lag time before the wash liquor reaches the sample point.

Samples will need to be taken at regular intervals during each stage of the cleaning cycle. The length of the intervals will depend on the length of the stage.

A rinse phase that lasts for 5 minutes may require sampling every 30 seconds.  
For a recirculating caustic cycle, may take only one sample.

If you use the same container to capture all the samples, be sure to rinse it thoroughly between each sample as otherwise the samples can be contaminated by previous samples.

It is recommended that the samples are poured into separate bottles and labelled, then measured after the CIP has finished.

Measure the parameters that are appropriate to each stage. Table 3 summarises what to check for in each stage of the CIP cycle. Table 4 gives suggestions on methods of measuring the parameters. You will also need to know the approximate flow rate.

Table 3: Sample and Measurement Guide

Phase	Purpose	Check for:	Parameters to check (as appropriate)
Initial rinse	Removal of product, cleaning the process equipment	Sufficient removal of product Excess rinsing after all product is removed	Colour, turbidity, brix (sugar concentration), pH, conductivity
Reagent: caustic, acid, detergent, EDTA, etc	Further cleaning of system	Concentration is within efficient limits. Cleanliness of liquor.	pH (for acid or caustic), conductivity (for caustic) visual
Final rinse	Removal of cleaning chemicals from equipment	Concentration of cleaning chemicals. Final rinse stages should be fairly clean water.	pH (for acid or caustic), conductivity (for caustic)

Table 4: Suggested Methods for Measuring CIP Wash Liquor Parameters

Parameter	Suggested measurement methods
Colour	visual
turbidity	Turbidity meter Visually (cloudiness)
pH	Indicator (e.g. phenolphthalein or other indicator to show acid, neutral or basic conditions) pH testing strips litmus paper pH meter
Conductivity	Conductivity meter (EC) Total Dissolved Solids (TDS) – either by lab analysis or simple drying test (Part III section 1.3.1) and convert TDS to EC. (conversion chart)
Sugar	Brix meter – hand held or inline, automated or manual Sugar indicator strips (available from chemist for diabetic testing)
Flow rate	Record from PLC screen, or work out from pump speed and pump chart Find the time taken to pump the volume of liquid (such as from size of tank/vessel). Flow rate =volume / time. See Part III section 1.3.3 for further ideas.

### Step 5: Analyse the CIP data

Once measurements are taken, look at the results. Is there anywhere where the CIP is over rinsing? Or perhaps not rinsing enough and product is not properly removed. Are there other changes that could be made to reduce water use while still cleaning effectively?

To determine whether the system is over-rinsing, set out the samples and examine them. Where does the product in the sample completely disappear? This is the point where the rinse is finished doing its job, but you should allow for at least 30 seconds more to be safe (Plate 1). How much longer than this point does the rinse extend? If it continues for an additional 5 minutes then you can say the CIP system is over rinsing by this amount and you can calculate the amount of water that is related to the extended rinse time.

Plate 1: Example of samples collected during a first rinse



Often there is a large amount of safety factor built into the cleaning and rinsing cycles. While it is good to have a margin for safety/certainty, often a significant volume of water can be saved by reducing these margins. If safety or reliability is a concern, perhaps this can be assured in other ways, such as installing inline turbidity, conductivity meters, or other forms of measurement, which can either be used to control the process or can act as an alarm if something unusual happens.

It may be helpful to go through the worked example in Appendix 2 when analysing your results. The analysis of this data will enable you to develop a list of actions which will save water, reagent and/or product. These actions should be recorded in a clear and concise way. One way to do this is to use a table like that found in Appendix 1.

## 2 Implementing Best Practice into your CIP System

This section describes a method to help decide which potential actions to implement into your system.

### 2.1 Summarise Potential Improvements

Add the actions resulting from the CIP policy assessment (Part I section 4.0) and the best practice summary (Part I section 3.0) to the Table of Recommendations and Actions, found in Appendix 1.

### 2.2 Identify the Savings and Cost of each Recommendation/Action Item

The savings and cost of implementing each recommendation/action will help determine whether they are feasible or not. The savings and costs come from a variety of sources. Take into account the following types of possible savings and costs.

#### Savings

1. Water (work out volume per year, then dollar value of this. This information is available from the water bills)
2. Chemicals (kg or L saved, then cost per year. The accounts department will be able to tell you the cost of detergents etc.)
3. Labour saved
4. Production downtime (most companies have an idea of how much an hour of production downtime costs in lost earnings)
5. Trade waste savings. Estimate the volume reduction then look up the trade waste bill to get the volume charge and calculate how much money is saved. You may also need to negotiate a new trade waste agreement with the Water Authority. This could involve taking some samples for analysis to verify the savings for the new trade waste agreement.
6. Product waste saved, if more product is now recovered.
7. Energy costs for waste heat recovered
8. Cost of OH&S issues

#### Cost to implement

1. Capital works. If the project requires construction or installation of new equipment, there will be capital costs involved. Usually a rough design is undertaken initially by an engineer, and the costs estimated to within +/- 30%. If the project seems feasible, a more detailed design and feasibility study will be undertaken, and the costs estimated to a more accurate level. When costing capital projects include costs for: equipment, installation, labour, electrical and plumbing work, project management, detailed feasibility studies where appropriate, and commissioning. It may also pay to check whether there is any suitable

equipment already owned by the company that is not currently being used. We have found that sometimes there is a surplus tank or pump that can be used for CIP. This reduces the cost of the project and could make the difference in whether the project is feasible or not.

2. There may be increased chemical costs if changing reagent.
3. Validation of changes may require additional lab testing – this is a cost if outsourced.
4. Downtime of staff if they are involved in meetings, training.

### **2.3 Identify a prioritise each action item**

The priority assigned to each action will depend on the key constraints for your system identified in Part I section 4.1, and also the benefits they bring in terms of water savings and so on.

If water saving is a key target for your company, the recommendations and actions that save the most water will take higher priority. If staff health and safety is a key concern, then the projects that best address this issue should be the top priority.

You should also consider which recommendations/actions will make a difference for a low or zero cost, and assign a high priority to these.

### **2.4 Progressive Implementation**

Once you have a list of actions to take and priority for each action, this can be used as a plan for implementation of best practice.

Measure the effect of the changes as you make them, as this can be useful for reporting to the wider company, and even the public.

Many companies publish information about their water-saving and environmental efforts.

An example of this is Fosters Brewery:

[http://www.fosters.com.au/about/docs/Abbotsford\\_Fact\\_Sheet.pdf](http://www.fosters.com.au/about/docs/Abbotsford_Fact_Sheet.pdf)

It is often wise to make gradual changes to your system, rather than large changes all at once. This can help to minimise the risks involved. If you are over-rinsing by 10 minutes in the CIP cycle, then instead of cutting the rinse by 10 minutes straight away, try gradually shortening the rinse times, perhaps by 2 or 3 minutes at a time and observe what impacts this has on the system and the clean it produces. If all is working well, then the next step in reducing the rinse time can be taken, until the intended length is reached. See section 3 for information on validating changes made to your CIP System.

An investigation of a CIP sequence may show that you can reduce the first rinse times from a total of 20 minutes to 7 minutes. It may be advisable to reduce the rinse length gradually, perhaps by 3 minutes initially and reassess the cleaning impact using additional swab tests. If the swab tests show that the reduced rinse time has had no impact on quality control then the rinse time could be reduced by a further 3 minutes and the process repeated. This way you gradually reduce water consumption without placing any risk on product integrity.



## 3 Validation of Changes Made to CIP System

The changes you make to the CIP system should always be done in accordance with quality systems and food safety regulations. This is discussed in more detail below.

### 3.1 Quality systems

When changes are made to CIP operating parameters as part of the optimisation process, these changes must be validated within the quality system of the company. In the Australian food and beverage industry the quality systems are usually based on Hazard Analysis Critical Control Points (HACCP) and/or the ISO 9000 group of standards for quality management systems. Food safety is very important and the risks of any safety breach must be carefully managed. The cost to a manufacturing company of not meeting food safety or quality requirements can be very high: regulatory breach, fines, loss of consumer confidence, damage to perception of company brands, and the costs involved with unsuitable product or even product recalls.

### 3.2 Food Safety Regulations

Food companies will be aware of the relevant regulatory requirements and at all times must act within them.

### 3.3 Validating changes to CIP where CIP validation procedures exist

A food and beverage company may already have a procedure in place for validating changes in CIP parameters. The Best Practice Guidelines recommend that any CIP optimisation work is carried out and validated in accordance with the existing quality system and procedure. Regular, ongoing validation of CIP systems is also recommended.

### 3.4 Managing risk when no CIP validation procedure exists

When no procedure exists for validating changes to a CIP process, an appropriate procedure must be determined. A suggested method for creating a procedure to validate CIP changes is outlined below:

#### 1. Undertake a risk analysis

Identify the types of risks and events that could occur as a result of CIP changes which compromise food safety and quality standards. For each of these, identify the severity of the risk in relation to its potential consequences.

#### Cleaning requirements

Different processes and products will require different levels of cleaning. Part III section 1.4.1 contains a discussion on the four components required for cleaning: time, temperature, flow rate, and concentration.

#### Product quality

Key product parameters (E.g. pH, rheology, flavour, consistency, temperature, shelf life, colour, presentation, integrity of recipe, nutritional value, texture).

### Product safety

A food safety hazard is any biological, chemical, or physical property that may cause a food to be unsafe for human consumption (Food Hygiene Australia 2009) Examples include: Microbial contamination, foreign objects, solids, allergens, chemical contamination, product labelling

### Production related risks

Can relate to loss of production time, product waste, energy, water, labour (including overtime), chemicals and packaging.

### Safety

Can be affected by spills, leaks, trip hazards, and managed through safe handling of chemicals, Material Safety Data Sheets (MSDS) available for each chemical used, hazards associated with confined space entry.

## 2. Identify critical control points

What aspects of the process will have an impact on the risks identified above?

## 3. Identify a testing and validation plan for the CIP change process

How will the impact of the changes in the CIP process on each potential risk be assessed and checked? Ensure that all risks are addressed. (E.g. MSDS available, personal protective equipment (PPE) worn, work permits in place where appropriate, etc)

## 4. Trial the CIP process changes, and validate according to the testing and validation plan

Consider making changes in a sequential manner (small changes at any one time).

## 5. Have the changes produced the desired result?

Determine whether the proposed changes to the CIP process are beneficial in terms of resources and quality of clean, and that no risks have been compromised.

Any changes made need to be approved by the appropriate level of management.

## 6. Document the entire procedure including risk analysis, validation and decision making

This will ensure that the procedure that was undertaken can be audited, and as proof that quality and safety risks were addressed and a quality system has been followed. This will also provide a reference for future CIP optimisation investigations.

## 7. Monitor the System

Once the CIP changes have been implemented permanently, the system should be monitored closely for a period of time.

### 3.5 Methods to validate cleaning efficiency

There are many methods available for validating and verifying the clean achieved by a CIP system. Not all may be appropriate for each individual company or product within the company. This will be in line with current Quality Control criteria. Utilise HACCP system to verify the changes you make are producing an acceptable clean and not impacting on your product.

Examples include:

- Visual inspection
- Surface swabbing for microbial analysis
- Testing of product for microbial contamination
- Flavour and odour analysis
- Trace sprays
- PLC verification that CIP operating criteria have been met
- Analysis of samples
- Measurement of pH, conductivity, brix, turbidity, colour, and so on.
- Ongoing product testing

## 4 Case Studies

### 4.1 CIP Review at CUB (Fosters Group)

Carlton United Breweries provided the following case study for inclusion in the guidelines:

In 2007 a review of our Cleaning in Place (CIP) systems was undertaken. The objectives were to lower our environmental impact and operating costs by reducing water and chemical use and discharges to trade waste and at the same time improve the cleaning effectiveness.

To begin, water and chemical usage data for the different CIP systems was collated and analysed to identify the CIP systems with the most potential for improvement. The fermentation tank CIP system was identified as the best opportunity and the most likely to return a benefit for effort.

The fermentation tank CIP system uses caustic as the main cleaning chemical and that was regularly neutralised by the CO<sub>2</sub> left in the tanks after the beer is transferred out. This produces many tonnes of salt each year that is in turn discharged to trade waste.

Salt is particularly hard to remove during trade waste treatment and affects recycled water quality.

The CIPs have been fully automated so there is a high degree of repeatability attainable. The automation was designed to be flexible and easy to alter for fine tuning.

The CIP system has a separate pre rinse tank that collects final rinse water from one CIP and reuses it as the first rinse of the next CIP. We set a target of reducing the final rinse water to a bare minimum and then reusing all of that water twice over.

The pipe work design at the top of the tanks is not ideal because it has many dead legs that are hard to flush out. This can lead to excessive rinse water volumes being necessary. The pipe work would be very expensive to rework, so it was worth taking extra time to trial different approaches to the

rinsing cycles. By using the right combination of rinse volumes and paths and drain times we were able to cut the water use by 60% and achieve our target of using all CIP water twice.

Caustic use was dramatically cut by 85%. This was achieved by spending more time to evacuate CO<sub>2</sub> before the CIP and better use of the pre rinse tank. In turn this reduced the salt discharged from this CIP by 80 tonnes per year. Figure 5 shows the relative drop in caustic use.

Figure 5: Caustic Usage

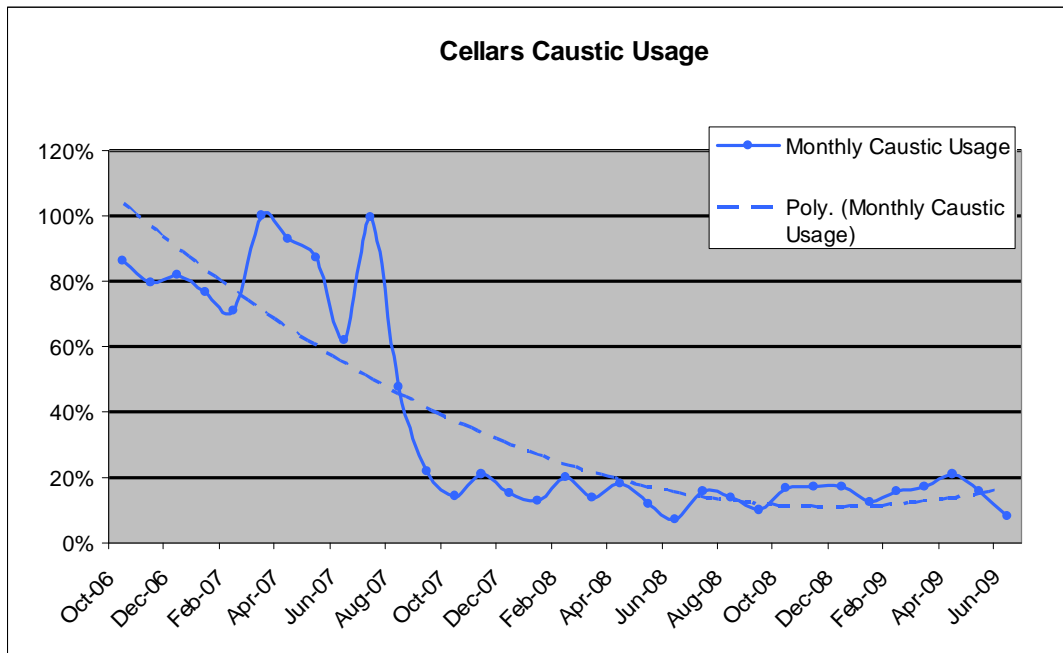

Cleaning effectiveness was also improved by ensuring the caustic strength is constant as shown in the following graph (carbonate % indicates the presence of caustic that has been converted to salt (Figure 6)).

Figure 6: Caustic Conversion to carbonate

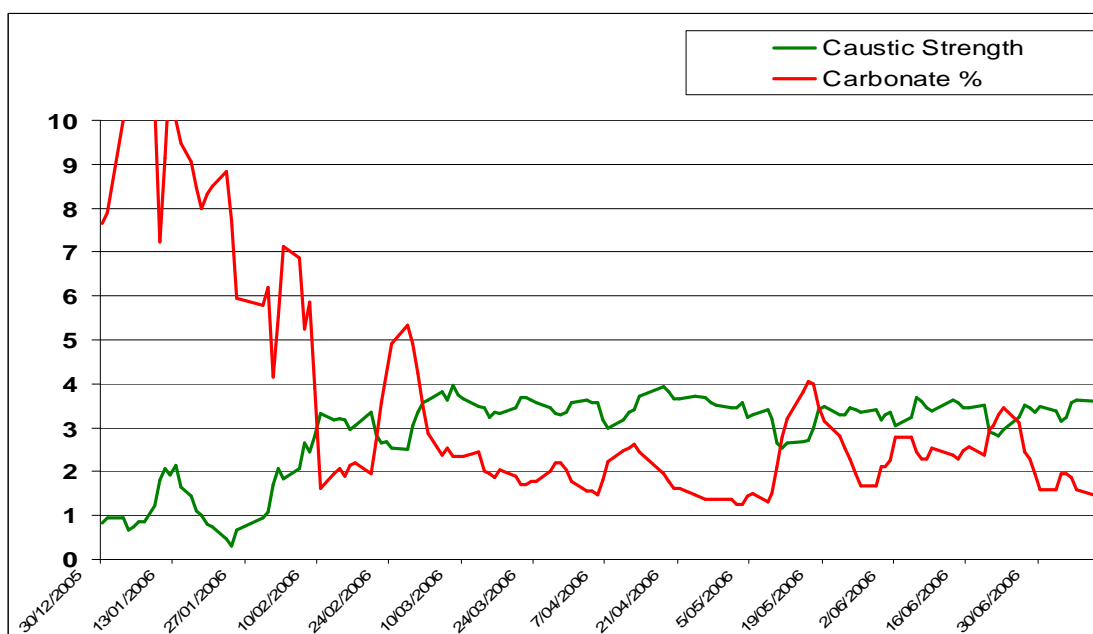

The microbiological results of these tanks reflect the improvements in cleaning and finding any counts is now very rare. All of these results were achieved with a back to basics approach and no capital outlay, just an investment of time.

The results were then used to develop capital projects to achieve the same or better results in other areas of the plant where additional equipment requirements were identified.

Figure 7 shows the proportion we have been able to reduce sodium discharge through this and other initiatives since 2001.

Figure 7: Sodium Reduction 2001 - 2009

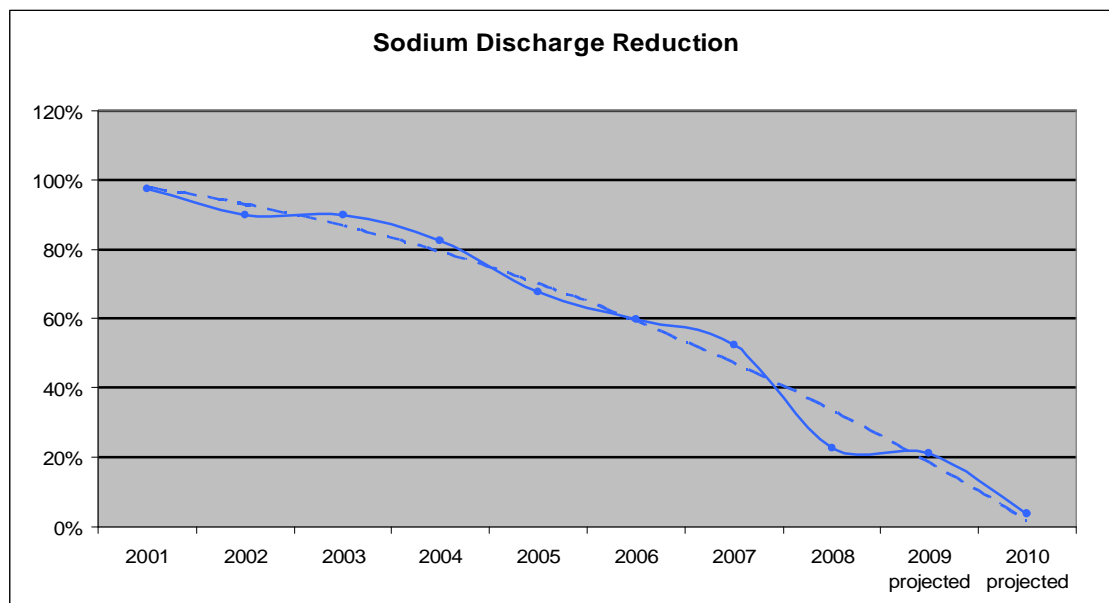

## 4.2 CIP Review at Saizeriya Australia

### Product

Saizeriya Australia is a processor and supplier of a range of ready to eat Italian style products for Saizeriya restaurants internationally. Saizeriya have 775 restaurants in Japan and 24 in China. The Melton operation supplies all the beef burgers, sauces and a range of soups to the restaurant chain.

### Scope of work undertaken

Hatlar reviewed the CIP on the white sauce line in detail and the white sauce tanks and meat sauce line in overview.

### Summary of Main Observations and Recommendations

The new Saizeriya processing facility installed best available technology. The automated CIP cleaning system utilises a 8,000L caustic mixing tank, a 8,000L acid mixing tank, a 30,000L rinse recovery tank and a 30,000L mains supplied process water tank. The system is controlled by a PLC which uses a timing sequence to initiate and finish the rinse sequences and conductivity set points to recover caustic washing reagent (caustic soda) and acid wash reagent (nitric acid) as it is chased out of the processing equipment by the rinse water. Rinse water following the caustic wash is recovered for

use in the first rinse. Rinse water following the acid wash is directed to drain. The acid wash is followed by sanitization which is recirculated and then solution is directed to the drain.

Table 6: Summary of Automated CIP System Characteristics and Opportunities

Characteristic	Description	Opportunities
Extent of Automation	PLC controlled automated system based on time and conductivity measurements.	
Instrument Control	<p>Initial rinse uses recovered water. Flush time determined by time only. White Sauce line 10 minute rinse. Meat Sauce line (includes soup) reduced rinse time depending on product but most often 10 minutes also.</p> <p>Caustic wash chases out recovered water rinse to drain until conductivity of 25mS/cm reached and then recirculated for 30 minutes.</p> <p>Rinse following caustic with mains water, recover caustic to caustic mix tank till conductivity of 10mS/cm reached. Rinse water then diverted to recovered water tank.</p> <p>Acid wash commences with acid chasing previous rinse water to recovered water tank till return conductivity reaches 25mS/cm. Acid wash recirculated for 25 minutes.</p> <p>Mains water then used in rinse to chase acid from system which is directed to the acid mix tank until conductivity drops to 10mS/cm when it is diverted to drain.</p> <p>Acid rinse followed by a 2 minute flush of mains water to drain when sanitiser is added and recirculated for 5 minutes and then drained by gravity.</p>	Install instrumentation to determine more accurately the removal of product during the product rinse.
Rinse Recovery	Post caustic rinse recovered for reuse in first rinse	Recover post acid rinse for reuse
Optimise Rinse Times	<p>Product rinse uses recovered water but is time related. A review of the time required to remove product shows over rinsing occurring.</p> <p>Final rinse after acid wash not recovered.</p>	The observations of the product rinse indicate that the rinse cycle could be reduced by up to 7 minutes and still adequately remove the product from the production system. However, the product rinse is balanced with the rinse used to remove the caustic and the initial water resulting from the commencement of the acid wash. In order to reduce the water used in the product rinse an evaluation of the quantity of water used in the post caustic rinse is necessary. A reduction in post caustic rinse water will result in less water collected in the reclaim water tank and allow a reduced volume to be used in the initial product rinse.

		Consider installing an acid wash recovery tank which would save up to 1.2ML/annum of rinse water.
Cleaning Reagent Recovery	Caustic and acid based cleaners recovered after cleaning using conductivity set point of 10mS/cm. This ensures that around 80%+ of the cleaning reagents are recovered to the reagent mix tanks for reuse. The remaining caustic reagent is recovered for a second use in the recovered water tank.	Acid washing following caustic washes is generally only required on product lines where dairy derived components are a major constituent of the product. This suggests that it may not be necessary to regularly acid wash the meat sauce line when used for products like corn and minestrone soup. Products on the white sauce line and tanks use an evaporated milk base and it is likely that regular acid washing of these lines after caustic washing is necessary. However, it is probable that acid washing is not required on every CIP run and that adequate removal of caustic resistant soil could be achieved at a reduced acid wash frequency.
Caustic Tank – reagent disposal frequency	Reagent mix tanks dumped when it becomes over-soiled. This seldom occurs.	Install filtration to remove soil from cleaning solution which extends the life of the reagent.
Reagent Type	Sodium hydroxide based cleaner used at 1.4% concentration. Nitric acid based cleaner used at 1.4% concentration. Automated dosing to mix tanks using conductivity to determine concentration. Sanitizer (hydrogen peroxide, peroxyacetic acid & acetic acid). No other cleaners trailed.	Assess other cleaners. Combined sodium and potassium based hydroxides clean cooked on surfaces just as well but reduce sodium load in waste water. Other cleaners such as enzymes/chelating/complexing agents could be suitable for non-cooked on areas.
Product Recovery	Product produced in batches to match requirements (i.e. only the quantity required is made up). This reduces the likelihood of product remaining at the end of the run. Product remaining after production run in pipes and equipment is washed to drain.	Maximise product recovery by using instrument control to assess quantity of product in water interface. Recover product interface for reuse in other products or uses outside of factory (e.g. stock food).
Wash cycle variation with product	Limited changing of cycle times with equipment and product variation. Ability to shorten rinse times on meat sauce line but rarely done. Acid wash solutions recycle times reduced on tank wash cycle.	Discussions with operators indicated that approximately 80% of the time products are prepared on a shortened meat sauce line. The CIP sequence is setup assuming the full line is used. There is opportunity to reprogram the PLC controlling the CIP sequence to shorten the rinse and wash times to reflect the reduced level of soiled equipment to be washed.
CIP Equipment	Spray balls effective in tanks. Relatively high pressures and	

	flow rates achieve effective cleaning in the shortest time (17,000-20,000 L/h).	
Validation	Regular swabs to determine effectiveness of clean	

### Summary

While Saizeriya have installed a system utilising best available technology there is considerable scope for saving substantial quantities of water by optimising the rinse cycles, re-evaluating the need for acid washing after every CIP and reducing the wash and rinse times when the shortened meat sauce line is used.

## 4.3 CIP Review at Edlyn Foods

### Product

Edlyn Foods is a processor, supplier and marketer of a wide range of packaged products for the food service industry. Products include the following broad categories:

- Syrups, toppings, juices and cordials
- Powders (Drinking Chocolate, cocoa custard powder, wheaten corn flour, glucose, gelatine, baking powder)
- Desert Mixes (mousse, instant pudding, jelly crystals)
- Bakery mixes (muffin mix, cake mixes)

### Scope of work undertaken

The investigative work focused on the CIP cleaning of the liquid product holding tanks, the connecting pipe work, pumps and heat exchanger (tank 3 line). While the CIP cleaning operation for the factory is designed to include the majority of the processing steps the integration of much of the processing equipment into the automated CIP system awaits further installation.

### Summary of Main Observations and Recommendations

The automated CIP cleaning system at Edlyn utilises (3) two thousand litre tanks- a potable water tank for the final rinse, a caustic wash tank and a recovered rinse water tank. The system is controlled by a PLC which uses a timing sequence to initiate and finish the rinse sequences and a conductivity set point of 0.1% to recover caustic washing reagent as it is chased out of the processing equipment by the rinse water. Final rinse water is recovered for use in the first rinse. The CIP water management system is controlled by an air operated valve bank where the valve seats are flushed every few minutes in bursts of 1 – 2 seconds to the floor.

The automated CIP system is operating at near best practise. The quantity of water used in the automated system on a per annum basis is relatively small. Rinse times are short and rinse recovery is practiced. There is very little opportunity to increase the efficiency of the automated system. Options to reduce water or reagent use are limited to more sophisticated instrument control and reagent cleaning and as these require significant capital investment it is unlikely that they would be justified in this low use system. The biggest gains to saving water and reagent will come from connecting those parts of the processing operation not yet connected to the CIP system. This will not only allow recovery of rinse solutions and reuse of cleaning reagents it will also save labour and



time, particularly on the fillers where the mechanisms are dismantled and cleaned by hand after each use.

The recommendations for the automated system are:

- Re-evaluate the pre-rinse cycles to ensure that product removal is adequate

The observations of the caustic tank and the recovered rinse water tank suggest that soil is getting through the system and may suggest that the pre-rinse times are too short for some product lines.

- Regularly purge the caustic tank and the recovered rinse water tank

Hatlar observed that waste product was settling to the bottom of these tanks. Regular purging of small volumes will reduce soil loads and maintain a higher water quality. Consideration could also be given, particularly as more of the factory is connected to the automated system and production increases to installing a filtering system on the caustic tank as this would continually clean the caustic and significantly improve the life of the caustic solution.

- Consider changing either the caustic dosing pump or the air operated control valve

The caustic dosing pump has the capability to over-ride the control valve and over-dose the caustic tank. This results in the dosing pump being switched off and then relies on operator attention to ensure that the dosing pump is switched on before initiating a CIP. This appears to represent a small risk to cleaning integrity. There is a mismatch of dosing pump supplier of the equipment.

The recommendations for the non-automated CIP system are:

- Consider as soon as is practical connecting up the “Woods Room” and the fillers to the automated CIP system

The filler is dismantled and the components washed by hand after every production run. The pipe work to connect the filler to the CIP system is in place. Connecting the filler to the CIP system would not only save reagent but is likely to provide significant savings in labour hours, increase efficiency and possibly maintain a higher level of cleanliness.

The “Woods Room” also has ring mains installed to enable the equipment to be connected to the automated CIP system. While this will require some new pipe work the benefits would be substantial in terms of OH&S and reagent savings.

#### **4.4 CIP Review at International Flavours and Fragrances**

Product: International Flavours and Fragrances (IFF) manufacture a range of liquid and powder flavours and fragrances.

Scope of work undertaken: Observation of the CIP sequence of a powder blender

Main observations

- The first rinse was not effectively removing all product residue from the blender
- The cleaning chemical was not applied effectively to the entire surface area to be cleaned

- Cleaning chemicals are not recovered
- The automatic CIP system was not operational

#### Main recommendations

- Ensure that the pre-rinse is effective in removing all traces of product from the powder blender. Either by manually hosing down the blender interior, or investigate the use of different types of water dispersing attachments, such as spray balls or jet nozzles.
- Ensure that the appropriate cleaning reagent is applied correctly to the rinsed inside surface of the blender.

#### Further CIP optimisation

- It is recommended that the pre-rinse and chemical application issues are addressed initially. Once these are effective, further work can be done to minimise the water and chemical use.
- Potential options include:
  - Minimise rinse times
  - Recover cleaning chemical solution
  - Optimise chemical concentration
  - Recover final rinse water for use as pre-rinse water

#### Summary

IFF could benefit from further investigation of its CIP systems. The automatic CIP system for the powder blenders do not work consistently and is receiving continuing attention. There are some important recommendations regarding pre-rinse effectiveness and chemical dosing that, if implemented, would have a significant impact on the reliability of the clean.

### 4.5 CIP Review at Kraft Foods

Product: Vegemite and salad dressing

Scope of work undertaken: The vegemite area has three CIP units. The main unit outside the production area services the tanker bay and silos and the main TEFFE and Rotothem are CIP internally with use of any CIP station direct dosing.

It was determined that the CIP cycle in two different areas of factory would be observed.

#### Main Observations

- Several CIP sets are used within the factory.
- The verification of clean (as ensured by the PLC system) ensures a consistent clean that occurs as required.
- In filling area: use of pigging to recover product and reduce the amount of rinsing required during CIP.
- In Box set CIP: no capture of final rinse water for use as pre-rinse water.
- The Kraft CIP quality system, which is part of the global Kraft policy, is best practice. It involves annual validation of CIP systems, minimum standards that must be obtained during CIP, and design for sanitation procedures.

#### Main recommendations

- There are two CIP sets in the Vegemite area, (Box set and Separator set) and another two sets in the Salad area (Portion Control set and Salad set). All these could be combined into one set to service the whole area. The benefit of this would be efficient reagent and rinse water recovery, although the issue of allergens which are present in the salad dressing products would need careful consideration. This is a long term plan. In the short term, the

Box set could be replaced with the Portion Control (PC) CIP set which is currently underutilised.

- Consider using burst rinses (such as 10 seconds on, 20 seconds off) as these can use less water and rinse more effectively.
- Capture and reuse of final rinse water could replace the water used in initial rinse. If the final wash water was to be recycled, this would save approximately 1500-2000L of water per CIP cycle, or 300–400kL of water savings per year.

#### Summary

Kraft's system of ongoing CIP review, cleanliness standards, automatic CIP verification via the PLC control system and operator training is at best practice level, and provides a benchmark for other companies to aspire to.

### 4.6 CIP Review at Cadbury (Ringwood)

Product: Cadbury manufacture an assortment of chocolate bars and confectionary

Scope of work undertaken: The investigative work focused on the Picnic/Chomp cooking line and the Boost cooking line. The Picnic/Chomp line was observed post-CIP of the cooking vessels, and during the CIP of the cooking line pipe work. The boost line was observed pre-CIP.

#### Main Observations

- It was not possible to take samples of the wash liquor as there were no suitable points in the process to take samples from. This prevented a thorough assessment of the CIP being carried out.
- The time taken for each CIP cycle was one of the major factors for Cadbury in determining the CIP cycle parameters. The process equipment needs to be cleaned and available for production as soon as possible.
- Caramel burn on the inside of the cooking vessels was one of the more challenging aspects of cleaning the Picnic/Chomp and Boost lines.

#### Main recommendations

- Sample points will greatly assist in further assessment of the CIP systems.
- Consider recovering final rinse water for use in the initial rinse phase.
- Consider recovering and reusing caustic solution.
- Investigate alternative spray balls to help remove baked on caramel.
- Cadbury may benefit from regular measurement of CIP characteristics to ensure the reliability and consistency of the clean, and assist in 'fine tuning' the system to save water, chemicals, labour input and time.

#### Summary

The demand of Cadbury's production means that CIP cleaning of the processing equipment needs to happen quickly and effectively. Further optimisation of the CIP system must remain within these critical time and quality requirements.

## Appendix 1: Table of Actions and Recommendations

#	Recommendation	Potential Savings (water, energy, chemicals, labour, product, disposal, production downtime, other costs)	Non-quantified benefits (consistency, reduced contamination, OH&S benefits,	Cost to implement	Priority	Action and responsibility
1	Recover rinse water: Install tank, piping, pump, instrumentation	Substitute with final rinse water, Save 8 lines × 250 CIPs per annum × 900L per CIP = 1,800 kL or \$3,474 per annum	Potentially better cleaning using diluted cleaning reagent in rinse water	Requires design and costing by site engineer. Cost will depend on availability of suitable tanks, installation costs and automation costs	Medium	Site Engineer. Conduct feasibility study due date indicated.
2	Use high pressure hose to rinse out mixing tank before CIP starts. Recover product as sludge and dispose of to piggery instead of to trade waste	Water savings: 5,000L (\$8,000) Trade waste savings: \$8,500 (reduction in BOD, SS) Production downtime saved: 12mins x 400 CIP shifts x \$200/hr = \$16,000. Extra labour required: use existing staff		High pressure hose system: \$6,000 Payback = 0.2 years (2.4 months)	Medium	Raise purchase order for hose system, schedule staff training on new procedure. Responsible: Maintenance Engineer
3	Reduce first rinse times related to the findings of the optimisation study	8 lines × \$144.25 per annum = \$1,154		Adjustment of timer control cost negligible. Additional validation may be necessary.	High	Production Manager or Environmental Manager
4	Reduce caustic concentrations to 1%	8 lines × \$1890 per annum = \$15,120		Adjustment of dosing pump cost negligible. Additional validation may be necessary	High	Production Manager or Environmental Manager

5	Reduce final rinse times related to the findings of the optimisation study	8 lines × \$217.30 per annum = \$1,738		Adjustment of dosing pump cost negligible. Additional validation may be necessary	high	Production Manager or Environmental Manager
---	--	--	--	---	------	---

## Appendix 2: Worked Example of CIP Assessment

### Step 1: How to assess water use for CIP across the entire factory

Your business may have sub-metering on the CIP set/s or you may have completed a WaterMap which has already estimated the total quantity of water used in the CIP cleaning. Alternatively your system is operated by a PLC which enables you to see solution flow rates and times of operation of each part of the sequence so you can calculate the amount of water used by each CIP ( $\text{Flow rate L/h} \times \text{minutes}/60$ ). It might be that a CIP clean on the process circuit is completed as the last thing at the end of the production shift and in this case the mains water meter can be read at the start and the finish of the CIP to obtain the water used in the sequence. If your CIP cleans are undertaken during the production shift and you have no PLC measurement or flow meters installed then you will need to calculate the water used from more basic principles.

In the simplest CIP system, it is usual to fill/partially fill a tank or a kettle within the circuit with water for the rinse and wash sequences with the water from each sequence dumped to waste. In this case the volume added to the tank/kettle is the volume used for each sequence and is calculated by the volume of the tank/kettle ( $\text{cross-sectional area} \times \text{height of water for a flat bottomed tank}$ ). The volumes of the individual sequences added together give the total volume used for the CIP. This same system can be used if your CIP system uses a single service tank.

For a system where the cleaning reagent is recovered to a reagent mixing tank you may need to undertake additional measurements. To calculate the water used in a CIP sequence you need to know two things:

1. The time taken for each part of the CIP sequence.
2. The flow rate of those parts of the sequence that direct water to drain.

The time taken for the first rinse, the wash and the final rinse is usually indicated on the operating protocol or on the PLC screen but if this is not the case you will need to observe the process and time each step. Calculating the flow rate in the absence of a flow meter requires access to the end of the discharging pipe. If this pipe is plumbed directly into the floor drain (no access) it will be necessary to break the discharge pipe at a join as close to the discharge point as possible. Once the CIP process commences, flow rates can be measured by several means indicated in Part III section 1.3.3.

Once the quantity of water used in a single CIP sequence is known then the total used by the CIP system on a day, week or month can be estimated by assuming that similar quantities are used in each CIP sequence and multiplying this volume by the number of CIPs undertaken on that day, week or month. From this the generalised amount of water consumed in the CIP cleaning on an annual basis can be estimated. You might be quite surprised just how much water this equates to. It is a good idea to compare the water used in the CIP cleaning with the total water used by the business as this puts the cleaning process into perspective. Don't forget that you are not only paying for the water that comes into the cleaning process you are paying for it a second time as you discharge it to trade waste and if you heat it you are paying

an additional charge. Viewed in this way the cost of water can be a significant cost to the operation of the business.

## Step 2: Define the CIP system that will be assessed

The CIP system used will service different parts of the production line. It is unusual for the whole production process to be covered by one CIP sequence although this may occur in simple process lines e.g. mineral water bottling operation. Most production lines are broken up with a clean of the batch tanks, pipe work and pumps separated from the heat exchanger and separated from the filler.

Company A produces 6 different products. There are three production lines which are serviced by two CIP sets. CIP Set #1 services lines 1 and 3, and a CIP will be carried out on the entire line at once. CIP Set #2 services line 2, but will CIP only one section of the line at a time. There is also a Special Batch Cooker, which is not serviced by a CIP set, instead the cooking vessel is filled with water and flushed out. A breakdown of the different CIP configurations is shown in Table 1.

Table 1: Example: Range of Company A CIP sequences

CIP Set	Services	Equipment Variations	Product Variations
CIP Set #1	Line 1	Entire Line (batch tank, pump, line and filler)	Product A
			Product B
	Line 3	Entire Line (batch tank, pump, line and filler)	Product A
			Product C
CIP Set #2	Line 2	Mixing Tank only	Product E
			Product F
		Heat Exchanger only	Product E
			Product F
		Holding Tank and Filler only	Product E
			Product F
Special Batch Cooker (No CIP Equipment)	Special Batch Cooker	Cooker, outlet pump and pipe	Ingredient P

The next step is to find out whether each different CIP Set/Line/Equipment/Product variation has a unique CIP sequence, or whether the equipment is washed the same after processing Product A as it is after processing Product B. In many factories all sequences are identical as it is often the case that when the system is commissioned it is set up to clean the "hardest to clean" product. This often means that the equipment used when processing the easier to clean products is over rinsed and over washed.

In the example above it happens that Products C, D, E, and F are fairly similar in consistency and all have the same CIP sequence when Line 1 and 3 are being washed. However, Product A is more difficult to clean, and also contains allergens, so this product has a different CIP sequence (or PLC programming), with a longer caustic recirculation step and longer initial rinse step.

Each different line (1, 2, 3, and Special Batch Cooker) has a different CIP sequence, to allow for the different types of equipment configurations and volume. So the actual number of unique CIP sequences is 8 (Table 2).

Table 2: Actual number of unique CIP sequences at Company A

CIP Set	Services	Equipment Variations	Product Variations	CIP Sequence
CIP Set #1	Line 1	Entire Line	Product A	1
			Product B	2
	Line 3	Entire Line	Product A	3
			Product C	4
			Product D	
CIP Set #2	Line 2	Mixing Tank only	Product E	5
			Product F	
		Heat Exchanger only	Product E	6
			Product F	
		Holding Tank and Filler only	Product E	7
			Product F	
Special Batch Cooker (No CIP Equipment)	Special Batch Cooker	Cooker, outlet pump and pipe	Ingredient P	8

Each of the 8 CIP sequences will need to be observed and evaluated to optimise CIP cleaning on the site. However, start with one sequence and work through this and then apply the same strategy to each of the other 7 sequences.

Choose one CIP process and product to observe and optimise: CIP Set #1 / Line 1 / Product A.

Firstly find out how many times this CIP sequence is run per week and per year. Does the CIP run a fixed number of times every week, or does it occur pending the production run? For CIP Set #1/Line 1/Product A, we have assumed that a CIP happens after every production shift. Production of Product A usually runs five shifts per week. The factory operates for 50 weeks per year. The number of CIPs for CIP Set #1/Line 1/Product A is 250 per annum.

Identify the equipment (if any) used in the CIP (this is the CIP Set) and which equipment is cleaned in the CIP cycle.

- CIP Set #1 equipment: Mains water tank, caustic tank, sanitiser tank, CIP pumps.
- Line 1 process equipment cleaned during the CIP cycle: Mixing/batch tank, tank pump, pipe line and filling machine.

An example process diagram is shown in Figure 1.

Figure 1: Process Diagram for CIP Set #1 and Line 1 for Company A



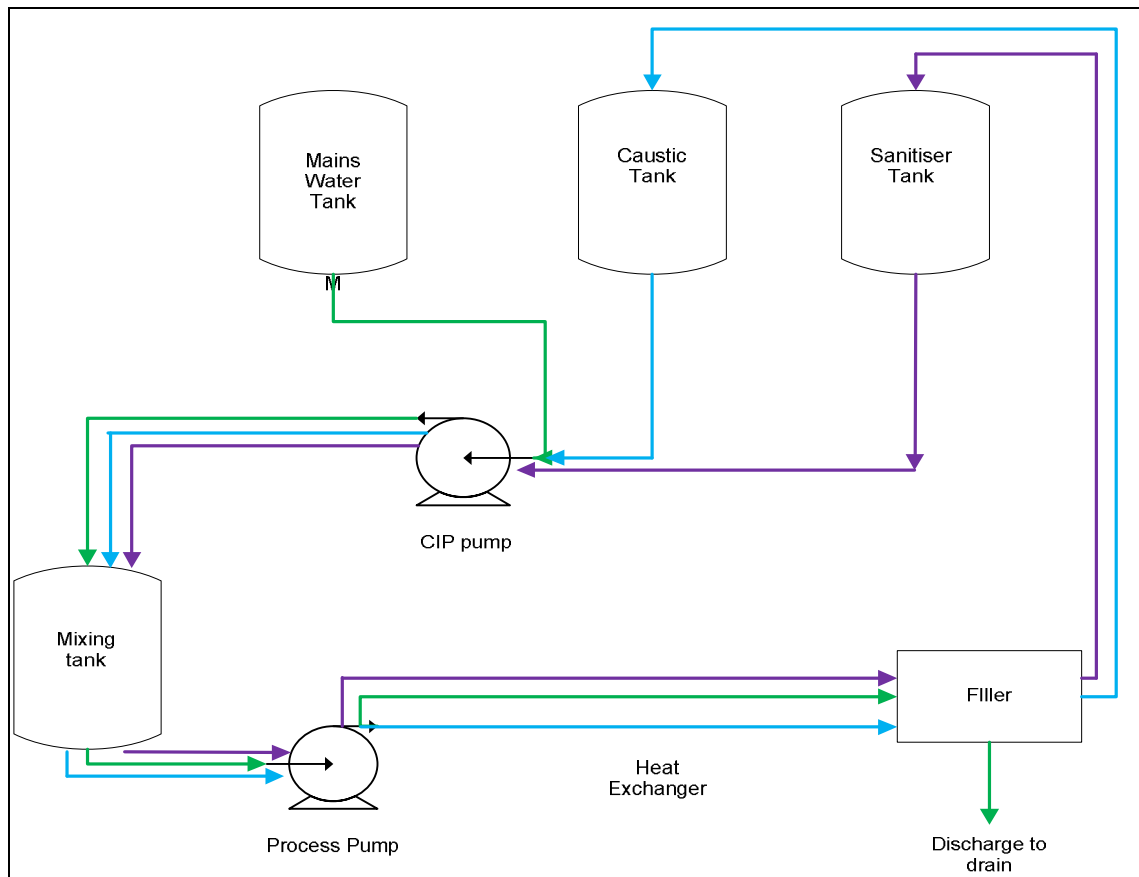

The CIP sequence is as follows:

1. Cold rinse direct from mains tank, 360 seconds
2. Drain to floor, 120 seconds
3. Caustic: recirculate through equipment and back into tank, 1200 seconds
4. Drain to floor, 120 seconds
5. Cold rinse direct from mains tank, 360 seconds
6. Drain to floor, 120 seconds
7. Sanitiser: recirculate through equipment and back into tank 540 seconds
8. Drain to floor, 120 seconds

### Step 3: Observe the CIP taking place

During this step you should use a stop watch to time the individual sequences of the CIP to ensure that they are operating as indicated in the protocol, operations manual or on the PLC. See Part II section 1 for more detail. Aspects of importance are:

Do the actual rinse times match what is supposed to occur? If not, have the conditions been changed by the operators? Why were the conditions changed?

What are the concentrations of the cleaning reagent? Are they measured? If not the concentrations should be checked using a conductivity meter or other technique such as that detailed in Part III section 1.3.4.

If the CIP includes reagent recovery, are the recovery set points and valves working effectively. What are the set points?

#### Step 4: Take Measurements of the wash liquor as the CIP goes through the cycle.

The purpose of this step in the optimisation process is to provide you with the information that will allow you to characterise each part of the CIP sequence.

The first part of the sequence is the removal of product from the production system. Samples taken during this phase of the sequence will allow you to assess if the rinse stage is too short or too long. Samples should be taken at 30 second intervals and then lined up to show the time sequence of the rinse (Plate 1). Colour can then be assessed subjectively.

Plate 1: Example of First Rinse Time Sequence (samples at 30 second intervals)

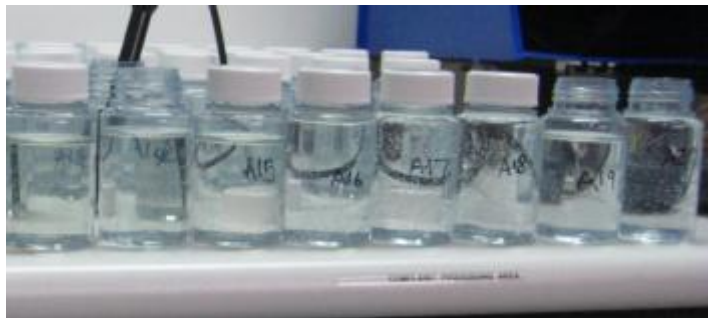

If the product does not have a significant colour it may have a conductivity signature or may contain sugar. In these cases methods of measurement such as a conductivity meter, brix meter, sugar indicator strips, pH indicator solution etc. may be useful (Figure 2).

Figure 2: An example of a conductivity signature of a first rinse

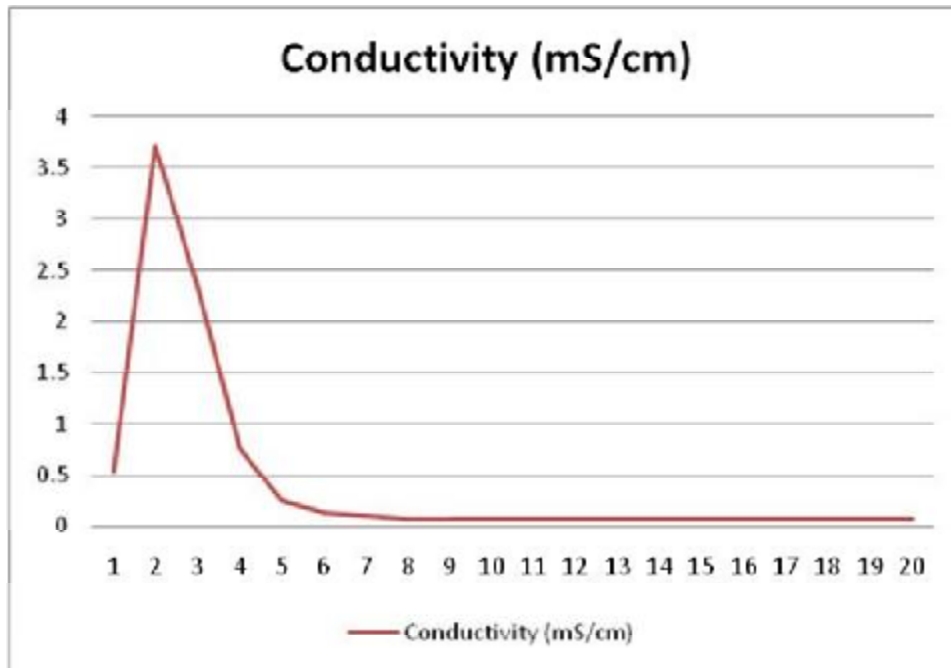

The second part of the CIP sequence is the caustic wash. Taking samples during this phase will tell you how soiled the wash solution becomes and what concentration is the wash solution.

The final part of the CIP sequence is the rinse to remove any residues of the caustic wash solution. Sampling during this phase will enable you to assess how long it takes to remove the excess reagent and whether over-rinsing is occurring. You can assess this by measuring conductivity (Figure 3) or pH or simply get a visual estimation by adding a drop of pH indicator to each sample (Plate 2).

Plate 2: Example of Final Rinse Time Sequence with Phenolphthalein Indicator Added to Each Bottle

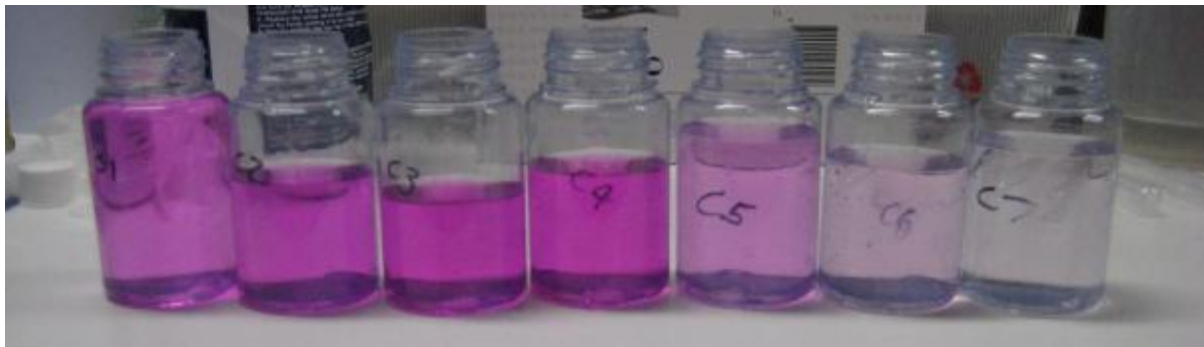
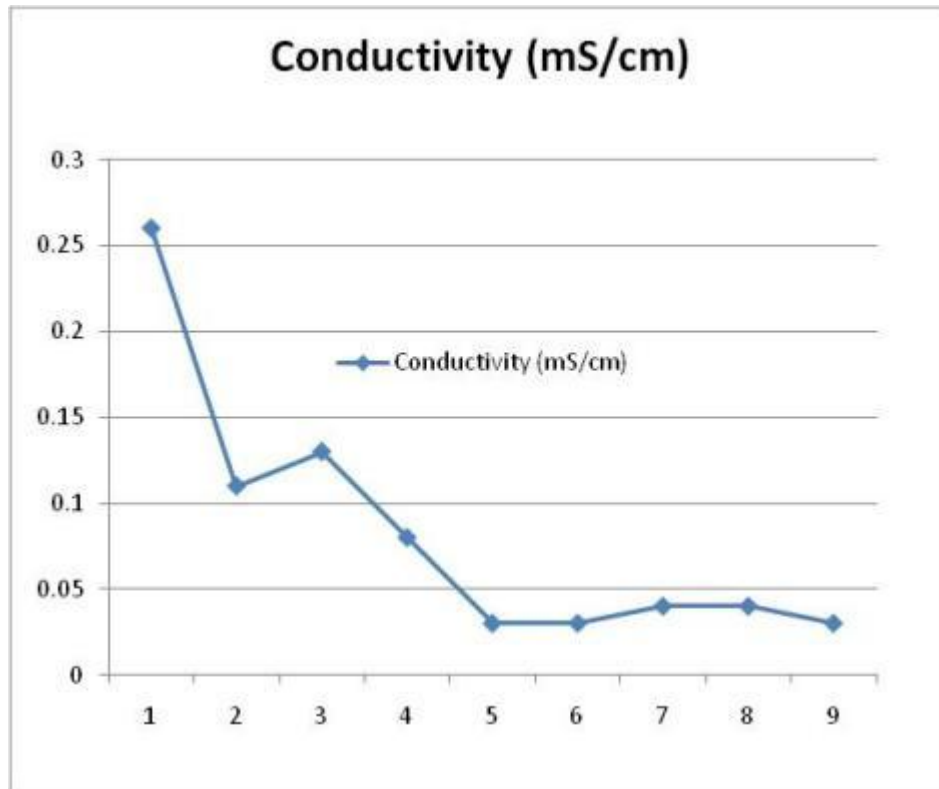

Figure 3: Example of Final Rinse Using Conductivity to determine when the Caustic is removed



You should note where the samples were collected. In many cases this will be from the point where the circuit discharges to drain. In other circuits a sampling point may be provided further up the discharge line. Samples were taken at the discharge to drain point.

The data collected from each CIP sequence should be recorded. One way to clearly do this is to fill in a table similar to that depicted below. Tables 3 – 5 show the data collected from an example CIP sequence when CIP Set#1/Line 1/Product A was evaluated.

Table 3: First Rinse Measurements

Sample	Time (s)	Colour	Sugar	Comments
1	30	Orange, cloudy	>2%	Flow rate is 150L/min
2	60	Orange, cloudy	>2%	
3	90	Orange, cloudy	>2%	
4	120	Orange, cloudy	>2%	
5	150	Faint colour, cloudy	1%	
6	180	Clear	0.10%	
7	210	Clear	negative	All product is rinsed out
8	240	Clear	negative	
9	270	Clear	negative	
10	300	Clear	negative	
11	330	Clear	negative	
12	360	Clear	negative	

Table 4: Caustic stage measurements

Sample	Time (s)	Observation	Conductivity (mS/cm)	Comments
1	240	Clear	18	Caustic is diluted at the start due to first rinse interface and incomplete draining of system.
2	480	Clear	65	Production circuit contains approximately 1000L of solution.
3	720	Clear	67	
4	960	Clear	66	
5	1200	Clear	65	

Table 5: Final rinse stage measurements

Sample	Time (s)	Conductivity (mS/cm)	Comments
1	30	18	Flow rate is 150L/min
2	60	4	
3	90	1	
4	120	0.7	
5	150	0.3	All caustic is rinsed out of the system by this point
6	180	0.28	
7	210	0.27	
8	240	0.29	
9	270	0.26	
10	300	0.27	
11	330	0.27	
12	360	0.28	

### Step 5: Analyse the CIP data

#### First rinse

Using Table 3 which depicts the first rinse it is clear that the entire product is rinsed out after 210 seconds. However the rinse continues for 360 seconds. It is clear that the rinse could be reduced by up to 150 seconds (note that it is usual to leave around 30 seconds additional rinse time after product removal to account for minor variations). So the rinse could be shortened, to 240 seconds long. Reducing rinse time by 120 seconds would save a considerable quantity of water.

*To work out the volume of water saved by reducing the rinse to 240 seconds:* Original rinse time minus the proposed new rinse time to give length of time saved. Therefore,  $360 - 240 = 120$  seconds and 120 seconds equals 2 minutes.

*Next we find out how much water is saved every CIP:* The flow rate of water for this rinse was 150 Litres per minute. So if 2 minutes of water flow is saved, and the water is flowing at 150 L/min, then  $2 \times 150 = 300$  L of water saved for each rinse of Product A on Line 1.

*To calculate the amount of water saved per year:* How many times does this CIP sequence happen every year? We know from Step 2 that the CIP happens after every production shift. Production runs for five shifts per week, for 50 weeks every year.  $5 \times 50 = 250$ , so this means that the CIP sequence runs 250 times every year.

If 300L is saved every time the CIP occurs and it happens 250 times every year, then  $300 \times 250 = 75,000\text{L}$  (75kL) of water could be saved every year by reducing the rinse time to 240 seconds long for this particular line and product.

*Next we will find out how much money this saves:* From Part III section 1.5.4 The True Cost of Water, we find that mains water costs \$1.22 per kL in the SEWL region. The cost of a kL of water is shown on your water bill. In addition the rinse water flows directly to the sewer so it contributes to the trade waste charge. Part III section 1.5.4 shows that a Trade Waste volume charge of \$0.56/kL applies to this water (check your bills for trade waste to accurately determine the volume charge for trade waste). Often the rinse water from food and beverage production will be acid and will require pH adjustment prior to discharge to the sewer. A rule of thumb to calculate this cost is around \$0.10/kL. Additional volume requires additional pumping more wear and tear and higher maintenance costs. This is often hard to calculate accurately but experience shows that maintenance of around \$0.05/kL should be allowed. The addition of these expenses will give us an indication of the cost associated with the annual operation of CIP Set #1/ Line 1/ Product A (Table 6).

Table 6: Calculation of the Potential Savings by reducing the First Rinse length

Mains Water Savings per annum	Trade Waste Savings per annum	pH Adjustment Savings per annum	Maintenance Savings per annum	TOTAL Reduced rinse time (per annum)
$75\text{kL} \times \$1.22 = \$91.50$	$75\text{kL} \times \$0.56 = \$42.00$	$75\text{kL} \times \$0.10 = \$7.50$	$75\text{kL} \times \$0.05 = \$3.75$	\$144.75

#### Caustic Wash Stage

Table 4 indicates that the caustic concentration is maintained at a concentration of 67 mS/cm. This represents around 1.4% caustic. While product A is somewhat harder to remove than the other products (Step 2 above), line one does not include an area where cooking of product onto equipment walls (e.g. heat exchanger) occurs and it is probable that the caustic strength can be reduced without impacts on cleaning and hygiene. Experience in industry has shown that concentrations greater than 1% caustic do not increase the cleaning rate or effectiveness. If the caustic wash reagent was reduced to 1% then caustic would be saved in each wash cycle.

*To calculate the amount of Caustic saved:* Table 4 indicates that the production circuit contains around 1000L of solution. If it is assumed that the caustic remaining in the production circuit is washed to drain by the following rinse then we have lost 1000L at a concentration of 1.4% caustic. If we reduced the concentration then we would have lost

1000L at 1% caustic. The difference is therefore 1000L at 0.4% caustic. This equates to  $1000 \times 0.4/100 = 4\text{kg}$  of additional caustic lost to waste.

The cost of caustic soda cleaning reagent should be obtained from the accounts department. However, this is generally around \$850 per tonne for 45% solution. This means that each tonne of 100% caustic costs  $\$850/0.45 = \$1,888$ . Therefore the cost of a kg of 100% caustic is \$1.89.

Each time CIP Set#1/Line 1/Product A is operated 4kg of caustic could be saved by reducing the concentration to 1%. This equates to a saving for each CIP of  $4\text{kg} \times \$1.89 = \$7.56$ . From Step 2 we know that this CIP run operates 250 times per year so the annual savings of caustic cleaning reagent would be  $250 \times \$7.56 = \$1,890$  per annum.

#### Final Rinse stage

Table 5 shows that the caustic wash solution has been removed from the circuit after 150 seconds. If we allow a 30 second safety factor we can see that the rinse extends for an additional 180 seconds without any benefit. Following the same procedure outline in the First Rinse Stage the quantity of water that could be saved can be calculated. Reducing the rinse length by 3 minutes (180 seconds) reduces the quantity of water consumed by  $3 \text{ minutes} \times 150 \text{ L/minute} = 450 \text{ Litres}$ . From Step 2 we know that the total number of CIP Set#1/Line1/Product A operations is 250 per annum so the total water that could be saved is  $450\text{L} \times 250 = 112,500\text{L}$  (112.5 kL). The total cost of this excess water is shown in Table 7 below.

Table 7: Estimated Savings from water reduction in the Final Rinse

Mains Water Savings per annum	Trade Waste Savings per annum	pH Adjustment Savings per annum	Maintenance Savings per annum	TOTAL Reduced rinse time (per annum)
$112.5\text{kL} \times \$1.22 = \$137.25$	$112.5\text{kL} \times \$0.56 = \$63.00$	$112.5\text{kL} \times \$0.10 = \$11.25$	$112.5\text{kL} \times \$0.05 = \$5.63$	\$217.13

#### Total Savings through Optimisation of CIP

The potential total savings that could be obtained from the optimisation of CIP Set#1/Line1/Product A is \$2251.88. CIP optimisation of the remaining 7 lines is likely to generate similar savings so the potential annual savings could be as high as \$18,000. These savings can be achieved at very little cost as they do not require an investment in major items of equipment. They involve the time to complete the optimisation study and then adjustments to timers or PLC control systems to change the rinse lengths and wash reagent concentration.

Further savings may also be possible by the addition of some capital expenditure. Adding a final rinse recovery tank would result in the substitution of mains water in the first rinse with water recovered from the final rinse. This would reduce water consumption in CIP cleaning by at least 30%. Further opportunities are highlighted throughout the Guidelines and these should be evaluated in relation to your specific system.

When the options have been identified these should be recorded in a clear and concise way. One way to do this is to complete the Table 8 on the following page.



Table 8: Recommendations and Actions

#	Recommendation	Potential Savings (water, energy, chemicals, labour, product, disposal, production downtime, other costs)	Non-quantified benefits (consistency, reduced contamination, OH&S benefits,	Cost to implement	Priority	Action and responsibility
1	Reduce first rinse times related to the findings of the optimisation study	8 lines × \$144.25 per annum = \$1,154		Adjustment of timer control cost negligible. Additional validation may be necessary.	high	Production Manager or Environmental Manager
2	Reduce caustic concentrations to 1%	8 lines × \$1890 per annum = \$15,120		Adjustment of dosing pump cost negligible. Additional validation may be necessary	high	Production Manager or Environmental Manager
3	Reduce final rinse times related to the findings of the optimisation study	8 lines × \$217.30 per annum = \$1,738		Adjustment of dosing pump cost negligible. Additional validation may be necessary	high	Production Manager or Environmental Manager
4	Install recovered rinse water tank	Substitute with final rinse water, Save 8 lines × 250 CIPs per annum × 900L per CIP = 1,800 kL or \$3,474 per annum	Potentially better cleaning using diluted cleaning reagent in rinse water	Requires design and costing by site engineer. Cost will depend on availability of suitable tanks, installation costs and automation costs	Medium	Site Engineer

**CLEAN-IN-PLACE BEST PRACTICE  
GUIDELINES – Part III  
Extra information on CIP**

**For**

**Smart Water Fund**

**August 2010**

ENVIRONMENTAL PROBLEM SOLVERS

ACN: 130 123 367  
ABN: 74 719 125 480

## Glossary

Atomisation	The process by which the chemical bonds in a molecule are broken to yield separated (free) atoms
BAT	Best Available Techniques or Technologies
BOD	Biochemical Oxygen Demand. The amount of oxygen required by aerobic microorganisms to decompose the organic matter in a sample of water
Brix	Unit of measurement of the amount of soluble material (usually sugar) in a liquid
Caustic	Colloquial term for Sodium Hydroxide (NaOH) - a strongly alkaline compound that is used in manufacturing for cleaning equipment and lines
Chemical Energy	The energy in a substance that can be released by a chemical reaction
CIP	Clean-In-Place. CIP is a practice for cleaning tanks, pipelines, and process equipment by circulating water and cleaning solutions through them without dismantling the pipelines or equipment
CIP circuit	The CIP sequence designated for a particular process i.e. for allergens/colour
CIP cycle	An entire CIP sequence
CIP Set	The equipment used while performing CIP cycles on the equipment
CIP sequence	The stages in which a CIP is conducted i.e. rinse, caustic wash, rinse.
COD	Chemical Oxygen Demand. The amount of oxygen required to oxidise all the oxidisable material (organics and inorganics) in a wastewater sample measured by a laboratory test
Conductivity	The ability or power to conduct or transmit heat, electricity, or sound.
Dead Leg	Any area in a piping system where water can become stagnant and where water is not exchanged during flushing
Denaturation Point	The point at which proteins lose their tertiary structure leading to the elimination or diminishing of their original features
Drain, sewer	A pipe or drain, usually underground, used to remove water and waste matter
EDTA	Ethylenediaminetetraacetic acid, a chemical alternative to NaOH for use in CIP cleaning processes
Emulsification	The process of combining two liquids that normally do not combine easily e.g. oil and water

Eutrophication	Eutrophication, often called algal blooms, result when water bodies , such as lakes, estuaries, or slow-moving streams receive excess nutrients (particularly nitrogen and phosphorous) that stimulate excessive plant growth (algae, periphyton attached algae, and nuisance plants weeds). The subsequent decomposition of this plant material reduces dissolved oxygen in the water column which can have negative effects on other aquatic life.
First rinse	The first rinse of a CIP sequence which can also be called pre-rinse, product rinse, initial rinse and first flush
IDS	Acronym for Iminodisuccinate. A chelating agent that combines with metal ions to remove them from waste water, also called sequestrants
Kinetic Energy	The work needed to accelerate a body of a given mass from rest to its current velocity
KOH	Potassium Hydroxide
MGDA	Methylglycin diacetate
NaOH	Sodium Hydroxide
NTA	Nitrilotriacetate
Ozone	Highly reactive compound that is commonly used for bleaching substances and for killing microorganisms in air and water.
Ozonated Water	Water with ozone dissolved in it to increase its oxidizing strength
pH	A measure of the acidity or alkalinity of a solution, numerically equal to 7 for neutral solutions, increasing with increasing alkalinity and decreasing with increasing acidity
Pigging	A 'pig' is typically an engineered plug or ball made of chemically resistant plastic that fits inside the pipe and is pushed through either by the product itself or another propellant e.g. water or compressed air
Pitot Tube	A device, essentially a tube set parallel to the direction of fluid-stream movement and attached to a manometer, used to measure the total pressure of the fluid stream.
Process equipment	Equipment which uses physical or chemical methods to increase the value of a raw material or product
Product recovery	To reclaim, reuse, recycle, or purify a product.
Reagent	Chemical solution such as Caustic/Acid/Sanitiser
Reagent recovery	To reclaim, reuse, recycle, or purify reagent
Reagent solution	A mixture of reagent and water to a required concentration.

Rheology	The study of the change in form and the flow of matter, embracing elasticity, viscosity, and plasticity.
Soiling	Product and other contaminants attached to the inside of the pipes and equipment
TDS	Total Dissolved Solids, this includes organic and inorganic TDS
Thermal Energy	The energy created when the kinetic and potential energy of an object in motion is combined, often referred to as 'heat'
Turbidity	Is the cloudiness or opacity in the appearance of a liquid caused by solids, particles and other pollutants.
TW	Trade Waste. Defined as liquid wastes other than sewage generated by business and disposed of through the sewerage system
Viscosity	The property of a fluid that resists the force tending to cause the fluid to flow
Water recovery	To reclaim, reuse, recycle, or purify water
Wash liquor	A solution of water and cleaning agent used to remove remnant soil from process equipment.
WWTP	Waste Water Treatment Plant: a facility containing a series of tanks, screens, filters, and other processes by which pollutants are removed from water.

## Contents

Glossary.....	2
1 Further Information .....	6
1.1 Chemicals used in CIP .....	6
1.1.1 Chemical Types/Issues/Benefits.....	6
1.1.2 Chemicals – Optimum concentrations.....	7
1.1.3 Chemicals – Alternatives to Sodium Hydroxide (NaOH).....	8
1.2 Equipment used in CIP.....	12
1.2.1 Hoses.....	12
1.2.2 Water Dispersal Mechanisms.....	12
1.2.3 Dead Legs .....	14
1.3 Measurement used in CIP.....	15
1.3.1 Water Meters .....	15
1.3.2 Measuring Water Flow Rate using Flow Meters .....	15
1.3.3 Measuring Water Flow Rate using Other Methods.....	17
1.3.4 Simple Method for Measuring Total Dissolved Solids (TDS).....	20
1.4 Components of the CIP process .....	20
1.4.1 Four components of CIP: temperature, concentration, flow, time.....	20
1.4.2 Sterilising.....	22
1.5 Water and Waste Water .....	27
1.5.1 What is Trade Waste?.....	27
1.5.2 The Impact of Sodium in Trade Waste.....	27
1.5.3 Fit for Use Water .....	28
1.5.4 The True Cost of Water .....	29
1.6 Human Resources.....	30
1.6.1 Occupational Health and Safety – CIP systems .....	30
1.6.2 CIP System and Adequate Training.....	31
References.....	34

## 1 Further Information

This section shows aspects of the Clean-In-Place systems which contain detailed information to help compare current practice within your company and how to improve it by considering the following components developed as part of the guidelines.

### 1.1 Chemicals used in CIP

#### 1.1.1 Chemical Types/Issues/Benefits

Chemicals used for CIP are dependent on the type of soiling that occurs as a result of the production processes. The Australian Food Safety Centre of Excellence (2007) states that detergents suitable for use in different types of soiling are:

1. Mineral deposits (including milkstone), protein scale – acidic detergent (apply periodically)
2. Starchy foods, fruits, sugar, salt, organic acids – mildly alkaline detergent
3. Fatty foods (fat, butter, margarine, oil) – mildly alkaline or strong alkaline detergent
4. High protein foods (meat, poultry, fish) – chlorinated alkaline detergent

Table 8 provides information about the type of detergent applications used within the food and beverage industry, their benefits and issues associated with each type.

A great deal of information is readily available on detergent applications and uses, however it should be noted that chemical suppliers are willing to work with the food and beverage industry to assist with cleaning solutions.

Table 8: Cleaning Agents- Benefits and Issues

Detergent Type	Benefits	Issues
<p>Sodium Hydroxide – Caustic soda (NaOH)</p> <p>Examples: SPECTRUM™ GLISSEN™ AVOID™</p>	<p>Typical product of choice for removing organic fouling deposits from food processes as the alkalinity saturates fouling deposits while also saponifying animal/vegetable oils</p> <p>Sodium costs less and has better solubility and cleaning efficiency than Potassium.</p>	<p>High concentrations of salt impact on water reuse for irrigation.</p> <p>Sodium salt changes the nature of soil and deteriorates the healthy growth of plants therefore it is not environment-friendly (Deakin University 2008).</p> <p>Water Authority discharge licensing requires that recycling be maximised. Recycling opportunities are limited by the quantity of sodium contained in the waste water and a large part of the sodium is derived from the cleaning processes in industry. Minimising the quantity of caustic soda based detergents used for cleaning will beneficially benefit the quality of waste water generated and will increase recycling.</p>
<p>Potassium Hydroxide Caustic potash (KOH)</p>	<p>Used for cleaning and disinfection of resistant surfaces and materials</p>	<p>Potassium contains larger molecules therefore more is required for</p>

Example: SUPERQUEST™	and is an alternative to sodium hydroxide which generates high salt concentrations in waste water	cleaning applications and KOH is more expensive than NaOH
Chelating Agent Ethylenediaminetetraacetic Acid (EDTA) Nitrilotriacetate (NTA) Methylglycin diacetate (MGDA) phosphates phosphonates (DTPMP, ATMP) polyphosphates iminodisuccinate (IDS) enzymatic detergents	EDTA is primarily used in the dairy sector to clear scale deposits and to prevent calcium and magnesium scaling, thus preventing sedimentation and incrustation in pipes, devices or containers (IPPC 2006).	EDTA forms very stable and water-soluble complexes which are not normally degraded in biological WWTPs, so the heavy metals remain in the waste water and not in the sludge, as they are discharged to surface waters.  EDTA can then also remobilise heavy metals from the sediment of rivers, furthermore Nitrogen contained in EDTA may contribute to eutrophication of waters.
Chemical additive  Examples: STABILON™ ALKA CLEAN ADDITIVE™	Used for caustic soda based CIP within the food industry.  In the dairy industry Alka Clean Additive when added to caustic soda quickly cleans protein from milk processing equipment (Melrose Chemicals 2008).	Chemical additives are high in cost and may lead to lime scale deposits in CIP tanks within the dairy industry
Surfactants	Lifts and emulsifies oils and fouling deposits by lowering the surface tension of the cleaning solutions for better wetting of surfaces and saturation of pores and crevices by capillary action and does not affect stainless steel	Severe damage may be caused to elastomeric seals, especially in applications where thermal load and pressure are involved.
Sequestrants Example: ALKYL POLYGLUCOSIDES	Widely used to remove hardness from water.  Sugar based surfactant is a mild product, neutral pH and good foaming capability (Showell 2005)	Hard water needs treatment such as ion exchange or the use of detergents and sanitisers containing specially formulated additives (Deakin University 2005).
Anti-foamers, corrosion inhibitors and oxidative boosters	Used in built caustics to counteract and suppress foaming caused by common surfactants which improves the ability to rinse caustic from the process	

### 1.1.2 Chemicals – Optimum concentrations

#### Optimal concentration of chemicals

Trials show there is an optimum NaOH concentration (~1%w/v), above which there is no benefit in cleaning effectiveness and in fact the cleaning rate actually decreases. Therefore the key lesson to communicate to plant operators is that 'more' is not always 'better' (DISC 2004).



The following table summarises the available research on optimum concentrations of reagents used in CIP in different applications.

Table 9: Optimum Concentration of CIP Reagents

No.	Chemicals	Concentration	Unit	Applied to
1	NaOH	1%	w/v	Dairy industries (Palmowski 2005)
2	NaOH	2%		Remove and kill biofilms (Palmowski 2005)
3	HCl	0.05	wt%	RO membrane fouled by whey (Palmowski 2005)
4	NaOH	0.1	wt%	RO membrane fouled by whey (Palmowski 2005)
5	NaOH	0.3	wt%	Membrane cleaning (Palmowski 2005)
6	Ultrasil 11	0.3	wt%	Membrane cleaning (Palmowski 2005)
7	Ozone	0.3%	v/v	Pre-treatment prior to alkali in removing protein (Palmowski 2005)
8	Enzyme Protease A	1	mg/ml	Removal of protein material from membrane (Palmowski 2005)
9	Lipase A	1	mg/ml	Removal of protein material from membrane (Palmowski 2005)
10	Mixture of lipase A and triton X100	1	mg/ml	Removal of protein material from membrane (Palmowski 2005)
11	Enzyme Protease A	3	mg/ml	Removal of lipid material from membrane (Palmowski 2005)
12	Lipase A	3	mg/ml	Removal of lipid material from membrane (Palmowski 2005)
13	Mixture of lipase A and triton X100	3	mg/ml	Removal of lipid material from membrane (Palmowski 2005)
14	$\alpha$ -CT	0.01	wt%	Membrane fouled by BSA and whey (Palmowski 2005)
15	NaOH	1%		Typical CIP regime (Palmowski 2005)
	Nitric acid (HNO <sub>3</sub> )	1% 0.5 – 0.8%		Removal of tough mineral deposits in heat exchangers and evaporators (Palmowski 2005) Butter manufacturing process
16	NaOH	3-4%	w/v	Stainless steel microfiltration membrane fouled by terephthalic acid solids (Kim 2002)
17	Sodium hypochlorite	0.75%		Removal of proteinaceous material (Gruzczynski 2004)
	Ethyl acetate	N/A		Removal of non-proteinaceous material (Gruzczynski 2004)
	Acid	0.5-1%		Neutralise caustic wash (Watson 2004)

### 1.1.3 Chemicals – Alternatives to Sodium Hydroxide (NaOH)

There is an ever growing concern to reduce sodium and Total Dissolved Solids (TDS) in trade waste discharge as this limits water recycling due to the significant impact on soil productivity.

For this reason it is important to reduce sodium levels in waste water by opting to use alternatives to sodium hydroxide (or caustic). However, the general adoption of alternative cleaning chemicals has been limited by inertia to change and the cost of using alternative cleaning agents. Potassium Hydroxide (KOH) can readily be substituted for the standard Sodium Hydroxide (NaOH) cleaners but direct substitution has been limited because approximately 40% more KOH is required to meet similar cleaning concentrations and the purchase price of KOH is generally higher. Manufacturers of cleaning products have recognised the need to reduce the concentration of sodium in cleaners and have introduced cleaning products using blends of KOH and NaOH to reduce cost. Other product blends aimed at achieving equivalent cleaning while minimising the cost difference have reduced sodium concentrations and added oxidants such as chlorine, chelating agents and dispersing agents. Other sodium free products have been developed to substitute for caustic soda for specific purposes. The cost of these alternative cleaning agents such as enzymes, EDTA and acid based cleaners can often be lower or equivalent to using caustic soda based cleaners. The cost effectiveness of these alternative cleaners can be increased by using chemicals designed for the specific cleaning task, limiting the concentrations used to the minimum required to achieve the necessary clean and recovering cleaning reagents for reuse. Talking to your chemical supplier about what you do and what you require will enable them to recommend alternative cleaning reagents to meet your specific requirements. Often this can be accomplished at a cost close to that of the commonly used caustic soda.

Some examples of the types of alternative cleaning chemicals are detailed below. This is not an exhaustive list as each chemical supplier has their own branded reagents which are often used in specific duties. It is recommended that you discuss the availability of sodium free or sodium blend cleaning reagents with your chemical supplier.

#### *1.1.3.1 Alkaline cleaner with medium sodium concentrations*

Chlorozolv™ is a chlorinated alkaline cleaner which is composed of 20% w/v as sodium hydroxide, active chlorine, stable chelating and dispersing agents, and sodium content  $\geq 11.5\%$  (Palmowski 2005).

Chlorozolv™ can be used in dairy farms and factories, meat and food industries for:

- Cleaning stainless steel plants in dairy and food industries
- Food processing equipment, silos, pipelines and heat exchangers
- Periodic cleaning of long-term protein fouling on stainless steel plant

Benefits of use are:

- Low foam
- Excellent protein dissolving power
- Bacterial properties
- Effective milkstone removal

### ***1.1.3.2 Alkaline cleaner with low sodium concentrations***

Diverwash VC24™ is a mild alkaline cleaning detergent which is composed of Sodium of 1.8% w/w, wetting and buffering agents, sodium hydroxide of 5-15%, sodium hypochlorite of 5-15%, chlorine-based bleaching agents of 5-15%, and polycarboxylates of <5% (Palmowski 2005).

Diverwash VC24™ can be used in food, beverage, meat, dairy, confectionary, and airline service industry for:

- CIP and spray washing applications

Benefits of use are:

- Reclaimable
- Safe for use on soft metals e.g. aluminium and galvanised mild steel
- Low foaming and therefore suitable for use under conditions of high turbulence and high pressure

### ***1.1.3.3 Potassium (KOH) /Sodium (NaOH) Blend***

Redes™ is a potassium and sodium blend cleaner which is comprised of disodium of <5%, sodium hypochlorite of <5%, phosphates of 15-30%, chlorine-based bleaching agents of <5% and sodium content of 4.4% w/w (Palmowski 2005). Redes™ can be used in the food and beverage Industries for:

- CIP and spray washing applications at 50°C
- CIP of milk tanks and packing machines at 40°C -50°C
- CIP and spray washing applications across the Food and Beverage industries
- Mechanical soak cleaning, soft metal safe spray washing and CIP of freezers in the Meat processing industry
- Packing machines
- Milk tanks

Benefits of use are:

- Reclaimable
- Low foaming under high turbulence
- Excellent protein removal properties
- Use on polycarbonate & PET bottles, containers and mould cleaning

### ***1.1.3.4 Potassium hydroxide (KOH) based product***

Superquest™ is a potassium hydroxide based cleaner which is composed of potassium hydroxide ≥ 30%, tetrasodium ethylenediaminetetraacetate of 5-15%, EDTA of 5-15%, and phosphonates of <5% (Palmowski 2005). Superquest™ can be used in the dairy industry to:

- Remove heat-treated organic and inorganic soils in single stage CIP

Benefits of use are:

- Reclaimable
- Highly effective if very high levels of protein & calcium soiling
- Low foaming
- Suitable for use in CIP systems under conditions of high turbulence

#### *1.1.3.5 Enzyme based cleaner*

Tergazyme™ is an enzyme based cleaner which is composed of protease enzyme, sodium dodecylbenzenesulfonate of 10-30%, sodium carbonate of 7-13%, and sodium phosphate of 30-40% (Palmowski 2005). Tergazyme™ can be used in the food industry to:

- Clean dairy equipment, reverse osmosis and ultra-filtration membranes, manufacturing equipment, tubing, pipes, process equipment, tanks, reactors

Benefits of use are:

- Concentrated – saves money
- Biodegradable and readily disposable
- Replaces corrosive acids and hazardous solvents
- Free rinsing

#### *1.1.3.6 Acid detergent*

Divosheen Dilac™ is phosphoric acid based CIP detergent/descaler (John Diversey 2009) is used in the food industry for:

- Cleaning, de-scaling and de-rusting processing equipment

Benefits of use are:

- Easy removal of heat modified soil and scale control
- Low foaming

#### *1.1.3.7 Alternative acid cleaner*

Citranox™ is a phosphate free acid based cleaner which is comprised of 10-30% citric acid, blend of organic acids, anionic and non-ionic surfactants and alkanolamines, and organic carbon of 17% w/w (Palmowski 2005). Citranox™ can be used in the food industry to:

- Clean dairy equipment, pipes, tanks, boilers, reactors

Benefits of use are:

- Concentrated – saves money
- Phosphate free, biodegradable, readily disposable
- Low foaming
- Removes metal oxides, salts and inorganic residues

## 1.2 Equipment used in CIP

### 1.2.1 Hoses

In general hoses without trigger controls or the right type of spray nozzle fitting, tend to waste water. This can occur when the hose is left running or the spray nozzle becomes clogged, brittle or is not suited for the purpose thus increasing water and energy consumption.

Trigger operated controls and nozzles can be fitted to hoses without much modification or expense and therefore reduce water and energy consumption.

Talk to your equipment supplier about which types of nozzles and trigger operated controls will help to improve hose efficiency which will lead to savings in time and money.

#### HIGH PRESSURE HOSES

Advantages:

- Less water is used per minute with a high pressure hose
- The high pressure hose cleans the equipment surface area more efficiently and quickly than a mains pressure hose – saving time and water.

Most companies tend to find a very short payback when changing from mains pressure hoses to high pressure hoses for cleaning.

### 1.2.2 Water Dispersal Mechanisms

Spray devices come in various types and sizes however our main focus will be on the comparison of two types:

- Fixed
- Rotating

#### FIXED SPRAY DEVICES

These two spray devices are more commonly used for low pressure, high flow and less demanding cleaning duties.



Advantages:

- No maintenance, no moving parts
- Special spray pattern
- Easier to monitor
- Less pump power

#### Disadvantages:

- Higher water usage
- Less mechanical action
- Less bounce back
- Longer cleaning times

Cleaning times of 30 - 40 minutes are not unusual. Atomisation can be a problem when pressures exceed 3 Bar. The maximum effective rinse range of this type of ball is between 2 & 3 metres. The spray pattern for each ball is fixed, however there are a wide range of spray patterns available to suite a wide variety of vessel shapes (NEM 2002).

#### ROTATING SPRAY DEVICES

These three examples show different types of rotating sprays, all of which provide high pressure with low flow application.



Turbodisc



Jets



Slotted

#### Advantages

- Low water usage
- Greater mechanical action
- Greater bounce back
- Greater throw distances

#### Disadvantages

- Higher pump power
- More difficult to monitor
- Generally higher cost
- More difficult to "Aim" spray
- Higher maintenance

Turbodisc tank washers are designed to produce a dense all-around spray pattern and to operate at low pressures. They are available in a 180° spray pattern for concentrated cleaning in one area of a tank or in a 360° pattern for all-around coverage (NEM 2002).

The Jet type of spray device is best suited to use in vessels that have difficult to remove "burnt-on" deposits. The high pressures and directional jet have excellent soil removal characteristics. Atomisation is rarely a problem; however a "boost" pump is often needed to ensure sufficient pressure is available. Cleaning can be achieved in a very short time (as little as 4 minutes in some sites). Both "open" and "encased" designs are available. Capital & maintenance costs are relatively high (NEM 2002).

The slotted rotating spray ball has evolved from the standard ball, offering the ability to handle somewhat higher pressures, with the inevitable reduction in cleaning times. Maintenance costs are higher than for a standard spray ball but lower than for a rotating jet (NEM 2002).

### 1.2.3 Dead Legs

A dead leg is any area in a piping system where water can become stagnant and where water is not easily exchanged during flushing. Bacteria in dead-end pipe lengths and crevices are partially protected from flushing and sanitisation procedures and can re-contaminate the piping system. Modern piping design limits the length of any dead-end pipe to 6 times the pipe's diameter (even shorter dead legs are preferred). This is the six diameter rule (Edstorm 2009). However, in practise dead legs should be limited to 3 pipe diameters in length as 5 or 6 pipe diameters could present cleaning difficulties (Sutton 2008).

Dead legs originate usually because of old circuit redundancies or new equipment installations making old equipment redundant. They can be common in old factories which have been upgraded. A vegetable oil manufacturer audited their water use and found redundant pipe work with a non-closing valve that was continuously discharging mains water to drain at 17 kL per day (6ML/a).

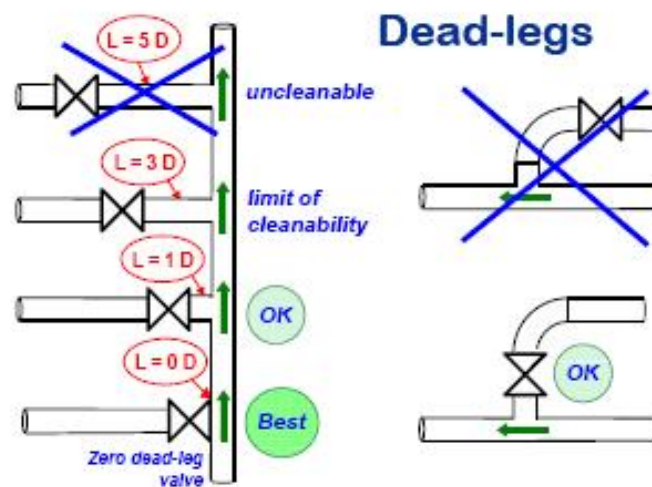

Figure 8: Diagram of two different types of dead legs (Sutton 2008)

Figure 8 on the left shows four types of horizontal dead legs. From top to bottom: one shows the length of the dead leg is too long which means the pipe work will be un-cleanable, two shows a limitation to the cleaning capability, three shows an acceptable distance for a dead leg, however four removes the dead leg altogether and this is the best option out of the four examples. For vertical dead legs as shown on the right, the top diagram shows that the dead leg will not be drained effectively where as the bottom one is acceptable.

Horizontal orientation is best because it offers the best chance of fully flushing the dead leg and removing gas bubbles during the CIP operation (Voss 1996).

There are two main problems posed by dead legs:

- First, cleaning fluids must be able to flush out trapped gas pockets in order to wet all of the piping surfaces in the dead leg.
- Second, fresh cleaning fluids must flush the dead leg to maintain rapid cleaning rates (NEM 2002).

Therefore it is essential that all pipe work is sloped continuously to drain points, the number of dead legs are minimised, and dead legs should be oriented such that they are easily cleanable and drainable and as much piping as is reasonable within a CIP should be of similar diameter (NEM 2002).

## 1.3 Measurement used in CIP

### 1.3.1 Water Meters

It is often said '*If you cannot measure it, you cannot manage it*'. Water meters help to identify the volumes of water used on site, whether it is for production, cleaning, amenities, heating/cooling, or other uses.

A good place to start if you do not have any water meters installed is to identify high use water areas and conduct a water balance. A water balance is a numerical account of where water enters and leaves your site and where it is used within the business. It lists the amount of water used by each main process. It can be quite simple or very detailed depending on your situation and needs.

Further information can be found in: Envirowise, 2002, *Water Minimisation in the Food and Drink Industry*

Available online from:

<http://www.envirowise.gov.uk/uk/Sectors/Food-and-drink/GG349-Water-Minimisation-in-the-Food-and-Drink-Industry.html>

Once you have completed the water balance then the water meters can be installed on supplies going into individual processes so you can see how much different processes or areas actually use. In this way you can decide where you can make the most savings.

### 1.3.2 Measuring Water Flow Rate using Flow Meters

You will need to know the flow rate of water in order to estimate the savings that can be achieved by reducing rinse times.

One practical way to measure water flow rate is by using a flow meter. Different types of flow meters are suitable for different types of applications. Thus, a careful selection of flow meter for particular application is needed. There are few things to take into consideration when choosing a water flow meter in CIP application, such as the expected minimum and maximum flows, the expected minimum and maximum pressure and determining whether the flow information will be useful if presented in mass or volumetric units (Omega 2009).

The following are different types of flow meters available in the market:



### 1. Rotameter or Variable Area Flow meter

This flow meter consists of a vertically oriented glass (or plastic) tube with a larger end at the top, and a metering float which is free to move within the tube (Engineering Toolbox 2005). Due to its low cost, simplicity, low pressure drop, relatively wide range ability and linear output, this type of flow meter is widely used (Omega 2009). The accuracy can be as good as 1% of full scale rating (Engineering Toolbox 2005).

### 2. Spring and Piston Flow Meter

This flow meter uses an annular orifice formed by a piston and a tapered cone. The calibrated spring at the base of the cone holds the piston. Piston-type flow meter is an economical alternative to rotameter for flow rate indication and control. This is due to its simple design and the ease with which it can be equipped to transmit electrical signals (Omega 2009).

### 3. Thermal Mass Flow Meter

This type of flow meter operates with minor dependency on density, pressure, and fluid viscosity. The true mass flow rate is determined by either a differential pressure transducer and temperature sensor (or a heated sensing element) combined with thermodynamics heat conduction principles (Omega 2009).

### 4. Ultrasonic Doppler Flow Meter

Dirty applications (e.g. wastewater and other dirty fluids and slurries) which normally cause damage to conventional sensors commonly utilize an ultrasonic Doppler flow meter. The basic principle of operation utilizes the frequency shift (Doppler Effect) of an ultrasonic signal when it is reflected by suspended particles or gas bubbles in motion (Omega 2009).

### 5. Turbine Flow Meter

This type of flow meter consists of a multi-bladed rotor mounted at right angles to the flow and suspended in the fluid stream on a free-running bearing. When using this flow meter, it is required to have a minimum of 10 pipe diameters of straight pipe on the inlet. A turbine flow meter can be used for clean liquids and viscous liquids up to 100 centistokes. It may have accuracy up to 0.5% of the reading (Omega 2009).

### 6. Paddlewheel Flow Meter

This is one of the most popular cost effective flow meters for water or similar fluids. When it is applied to liquids other than water, its chemical compatibility should be verified. It has a minimum requirement of 10 pipe diameters on the inlet and 5 on the outlet. The rotor of the paddlewheel sensor is perpendicular to the flow and contacts only a limited cross section of the flow (Omega 2009).

## 7. Positive Displacement Flow Meter

A positive displacement flow meter measures process fluid flow by precision-fitted rotors. Known and fixed volumes are displaced between the rotors. The rotations of the rotors are proportional to the volume of the fluid being displaced (Engineering Toolbox 2005). This flow meter is used for water applications when no straight pipe is available and turbine meters and paddlewheel sensor would see too much turbulence. This type of flow meter may be used for viscous liquids (Omega 2009) and all types of non-abrasive fluids. Its accuracy may be up to 0.1% of full rate (Engineering Toolbox 2005).

## 8. Vortex Flow Meter

This flow meter is also known as vortex shedding or oscillatory flow meter. It measures the vibrations of the downstream vortices caused by a barrier in the moving stream. The velocity of the flow is directly related to the vibrating frequency of the vortex shedding (Engineering Toolbox 2005). Its main advantages relative to turbine flow meter are its low sensitivity to variations in process conditions, low wear, also its low initial and maintenance costs (Omega 2009).

## 9. Pitot Tubes

Pitot tubes are one of the most used (and cheapest) ways to measure fluid flow. It measures the fluid flow velocity by converting the kinetic energy of the flow into potential energy (Omega 2009). It gives the some advantages, i.e. easy, low-cost installation, much lower permanent pressure loss, low maintenance and good resistance to wear (Engineering Toolbox 2005).

## 10. Magnetic Flow Meter

This type of flow meter employs Faraday's law of electromagnetic induction that states when a conductor moves through a magnetic field, a voltage will be induced. The voltage produced is proportional to the flow rate. In this case, the liquids serve as the conductor and the magnetic field is created by an energised coil outside the flow tube (Engineering Toolbox 2005). This flow meter does not have any moving parts and is ideal for wastewater application or any dirty liquids which is conductive (Omega 2009). Also, it can measure flow in both directions with equal accuracy. However, it has relatively high power consumption and can be used only for electrically conductive liquid fluids (Engineering Toolbox 2005).

### 1.3.3 Measuring Water Flow Rate using Other Methods

Flow meters give the most accurate measure of flow rate, but in many instances one needs to make estimations without them. There are several methods available to estimate the flow rate other than using the flow rate meter. Some suggested methods are as follows:

- Discharge from a Pipe

If the water can freely drop from a pipe, the flow rate can be estimated by using carpenter's rule. This is done by setting the outlet pipe level and measuring the horizontal distance travelled ( $X$ ) while the water falls through a known drop (Miller 1999), e.g.  $Y=13''$  (Figure 9). A ruler is used to measure the horizontal distance. By knowing the diameter of the pipe, the

discharge flow rate can be found in Table 10 in gallons per minute (gpm). A plumb bob can be used to measure the vertical drop Y if the pipe is not level. By finding the ratio of the unfilled portion of pipe (U) to the diameter of the pipe, flow rate of the pipe which is flowing partially full can be estimated in USgpm (Table 11) (Oregon State University 1994). A flow in US gallons per minute can be converted to litres per minute by multiplying by 3.7854.

Figure 9: Calculation of Carpenter's Rule for Flow Rate

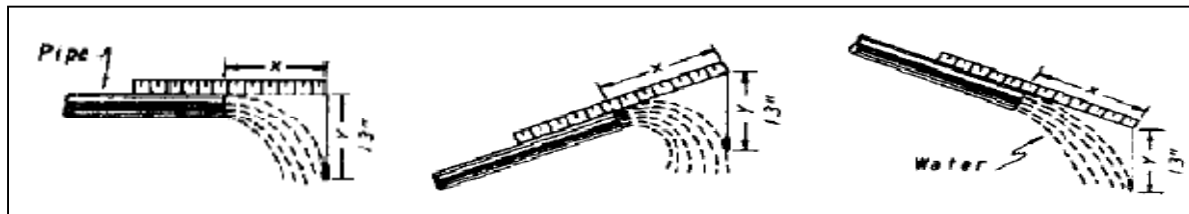

Table 10: Discharges (gpm) from pipes flowing full with vertical drop(Y = 13") and variable distance(X)

Pipe size		Horizontal distance X (in inches)												
Inside diam.	Area (sq in)	12	14	16	18	20	22	24	26	28	30	32	34	36
2.0	3.14	38	44	50	57	63	69	75	82	88	94	100	107	113
2.5	4.91	59	69	79	88	98	108	118	128	137	147	157	167	177
3.0	7.07	85	99	113	127	141	156	170	184	198	212	226	240	255
4.0	12.57	151	176	201	226	251	277	302	327	352	377	402	427	453
5.0	19.64	236	275	314	354	393	432	471	511	550	589	628	668	707
6.0	28.27	339	396	452	509	565	622	678	735	792	848	905	961	1013
7.0	38.48	462	539	616	693	770	847	924	1000	1077	1154	1231	1308	1385
8.0	50.27	603	704	804	905	1005	1106	1206	1307	1408	1508	1609	1709	1810
9.0	63.62	763	891	1018	1145	1272	1400	1527	1654	1781	1909	2036	2163	2290
10.0	78.54	942	1100	1257	1414	1471	1728	1885	2042	2199	2356	2513	2670	2827
11.0	95.03	1140	1330	1520	1711	1901	2091	2281	2471	2661	2851	3041	3231	3421
12.0	113.10	1357	1583	1809	2036	2262	2488	2714	2941	3167	3393	3619	3845	4072

$Q = \frac{3.61 AX}{\sqrt{Y}}$ , where:  
 A = Cross-sectional area of discharge pipe in square inches  
 X = Horizontal distance in inches  
 Y = Vertical distance in inches

Table 11: An approximate method to estimate discharge from pipes flowing partially full

$\frac{U}{D}$	Inside diameter of pipe = D in inches				
	4	6	8	10	12
0.1	142	334	379	912	1310
0.2	128	302	524	825	1185
0.3	112	264	457	720	1034
0.4	94	222	384	605	868
0.5	75	176	305	480	689
0.6	55	130	226	355	510
0.7	37	88	152	240	345
0.8	21	49	85	134	194
0.9	8	17	30	52	74
1.0	0	0	0	0	0

When the known drop is not 13", Table 10 or Table 11 cannot be used. In this case you need to calculate the velocity of the water before the water falls due to the gravitation (Miller 1999). This can be done by dividing the horizontal distance (X) by time needed before the water start falling. Once the velocity is calculated (ft/sec, m/sec) the flow rate can be found by multiplying this velocity with the cross sectional area of the pipe (Note the same units must be used). If there is noticeable constriction of the stream of water just outside the pipe, then the cross sectional area at the constriction needs to be measured and used in calculation instead of the cross sectional area of the pipe (Miller 1999).

- Average Cross Section

This method has a few assumptions, i.e. the pipe is horizontal, the water velocity is relatively low and distance travelled by the water is measured. A dye or other tracer is injected to the water at a known distance from the end of the pipe. The velocity of water can be calculated as mentioned in the above method by using the distance travelled by the tracer (X) divided by time needed for the tracer to travel that distance (Miller 1999). Flow rate can be obtained by multiplying the velocity by the cross sectional area of the pipe.

- Timed Volume

In this method, a container or bucket with known amount of volume is required. This time taken to fill the bucket with water (known volume) is then measured using a stop watch. The discharged water flow rate from the pipe is obtained by dividing the volume of water by the time required to fill the bucket (Oregon State University 1994).

- Pressure and Nozzle Size

This method is applicable for a sprinkler system. This can be done by inserting a pitot tube into the stream spraying from the nozzle when they are in operation and obtained the highest pressure reading. The flow rate can be read from data in Table 12 when the size of the nozzle is known. The total flow rate is obtained by multiplying the flow rate from Table 12 by the total number of nozzles (Oregon State University 1994).

Table 12: Flow Rate Related to Nozzle Size and Pressure

Pressure (psi)	Nozzle size (in inches)							
	3/32	1/8	9/64	5/32	11/64	3/16	13/64	7/32
35	1.50	2.70	3.40	4.16	5.02	5.97	7.08	8.26
40	1.50	2.90	3.60	4.45	5.37	6.41	7.60	8.87
45	1.70	3.20	3.84	4.72	5.70	6.81	8.07	9.41
50	1.80	3.10	4.04	4.98	6.01	7.18	8.49	9.88
55	1.90	3.30	4.22	5.22	6.30	7.51	8.87	10.30

### 1.3.4 Simple Method for Measuring Total Dissolved Solids (TDS)

A simple way to measure TDS loads is to use an evaporation method. When using this method it is usual to filter the samples to remove suspended solids. However, when dealing with relatively clean solutions, this step can be left out of the process if only an approximate measurement is required. A precise amount of sample is added to a clean, dry, and weighed container. This would normally be at least 200ml. The water is then evaporated in a drying oven at temperatures below 90°C. It is important not to let the solution boil as this can result in loss of liquid from the container and reduce the accuracy of the test. When dry, the container is again weighed. The difference in mass between the two weights is the mass of the total dissolved solids. Calculations are then performed to convert the change in mass to mg/L of TDS. This procedure does not require a sensor, but does require an analytical balance (0.001 or 0.0001 g resolution) (CCRI 2009).

The Community College of Rhode Island has developed a step by step methodology to measure TDS.

This can be found at the following link:

<http://74.125.153.132/search?q=cache:a5VipgAQf6QJ:faculty.ccri.edu/sgorelick/Test%252012%2520TDS.doc+TDS+measure+evaporation&cd=1&hl=en&ct=clnk>

## 1.4 Components of the CIP process

### 1.4.1 Four components of CIP: temperature, concentration, flow, time

CIP relies on the principal of applying suitable cleaning agents at optimum temperature, concentration and flow velocity for the correct length of time. The science is based on applying required amount of energy to the equipment to ensure that it is cleaned. In this case, the energy will be provided by the solution temperature (thermal energy), the use of cleaning agents (chemical energy) and the suitable velocities (kinetic energy) (Sutton 2008). The four most significant interrelated factors mentioned above affect the efficiency of the cleaning process. When designing a CIP system, these factors need to be considered carefully. This due to the effective specifications and controls of these factors, results in effective, repeatable, and reliable cleaning (Forder & Hyde 2005). These four factors are explained in the following.

- Contact Time

The contact time refers to the length of time that recirculation is established. It determines the duration of chemical and physical reactions involved in cleaning process which is directly proportional to cleaning efficacy. It supposes to cover the following phases:

1. Diffusion of the cleaning chemical into the soil layer
2. Swelling of the soil
3. Mass transfer phase from the soil layer into the liquid
4. Transport away from the surface (Palmowaski 2005)

The longer the contact time of the cleaning agents with equipment surface, the more effective the cleaning cycle due to the greater amount of soils being removed. Also, it reduces the requirement of the cleaning agent concentration (NEM 1997). However, this is a trade-off, because the time spent in cleaning is not spent in production (Hyde, Walter & Bader 2007). Contact time together with cleaning agent temperature must be determined based on the chemical characteristics of the residue and cleaning agents (Forder & Hyde 2005).

- Temperature

Temperature influences diffusion, mass transfer and fluid characteristics. These various parameters are inter-linked and directly related to the cleaning rate (Palmowski 2005). When the temperature increases, the chemical reaction rates and residue solubility of the soils are increasing. At the same time, cleaning agent viscosity and the chemical bond strength of the soil and the equipment surface are decreasing (Hyde, Walter & Bader 2007). The decreasing of cleaning agent viscosity will lead to increasing turbulence which means increasing mechanical force. The choice of "right" temperature is important because extreme temperature may 'cook'/'bake' soil on, thus it will be very difficult to remove (Dairy Safe 2006). Also, it may cause cracks in the welds and seams of certain vessels when there is expansion due to excessive temperature (Melrose Chemicals 2009). On the other hand, low temperature may reduce cleaning efficiency so that soil is not completely removed (Dairy Safe 2006).

Generally, 50% improvement of cleaning efficiency will be achieved when there is a 10°C increase in temperature above 30°C (Sutton 2008). It is found that for any food soil, the maximum temperature will depend on the temperature at which the protein in the system is denatured. Temperature above the denaturation point may increase the adhesion of the protein to the equipment surface than the cleaning efficiency is increased. Also, the minimum effective temperature will be approximately 5°C higher than the melting point of the fat.

- Cleaning Agent Concentration

Concentration of the cleaning agent must be maintained within set ranges, because this factor is also directly proportional to the cleaning rates. The chemical reaction accelerates when the cleaning agent concentration increases which leads to an increase in cleaning efficiency. However, it may also require extensive rinsing volumes and time (Hyde, Walter & Bader 2007). On the other hand, too low a concentration may not clean the plant effectively. The required chemical concentration will vary depend on the type of cleaning agent, type of soil and the equipment to be cleaned. As time and temperature are increased, concentration of cleaning agent is normally reduced (NEM 1997).

- Flow Velocity

To achieve efficient cleaning, the equipment surfaces must be contacted with cleaning agents with sufficient mechanical force. In general cleaning methods this can be as simple as hand-scrubbing. However, in CIP systems, it takes the form of turbulent flow which is directly related to the flow velocity according to the following equation (Sutton 2008).

$$Re = \frac{D\rho v}{\mu} \quad \text{(Equation 1)}$$

where Re = Reynolds number

$\mu$  = fluid viscosity

D = inner diameter of the pipe

v = fluid velocity

To obtain turbulent flow in a pipeline system, it is required to have  $Re > 3000$ . While for free-falling films over storage vats and similar containers, Re has to be greater than 200. Higher level of turbulent flow generally results in higher cleaning rates (Hyde, Walter & Bader 2007). This means higher velocity is desirable which typically reduces the required contact time, temperature and cleaning agent concentration (NEM 1997). Normally, the velocity is taken to be greater than 2 m/s<sup>(2)</sup> and  $Re > 30,000$  for a pipeline system gives the greatest effectiveness.

As it is mentioned above, each of the parameters would affect other parameters to some extent because they are inter-linked to one another. To a certain degree, a trade-off exists between one and another (Melrose Chemicals 2009). Application on particular plant operating practice would require each of these values to be altered independently to obtain the optimum cleaning operations. The best cleaning job at the least cost would be selected as optimum cleaning operations. The significance of the different parameters will vary with the method of cleaning used or with the type of soil to be removed.

#### 1.4.2 Sterilising

The aim of CIP is to chemically clean the equipment. This is defined as the removal of all residues of soil and all agents so that contact with the cleaned surface does not result in physical contamination. If this cleaned equipment needs to be micro-biologically clean as well then an additional process called SIP (Sterilisation in Place) is required (Sutton 2008). Moreover, when most stringent hygienic regulations are applied, it requires the equipment to be sanitized after cleaning prior to reuse for processing (Harper & Seiberling 1999).

SIP is the generic term for sanitizing, disinfecting (destruction of all vegetative cells) or sterilising (the statistical destruction and removal of all living organisms) on equipment (Higgins 2003). The aim of SIP is to kill any remaining microbial contamination (e.g. spores and hardy microorganisms) on the equipment surfaces that may have survived the CIP (Sutton 2008). This step does not replace CIP due to their different objectives. To achieve successful SIP, the pre-requisite is that the SIP has to be done after full CIP has been carried out. Any product remaining after cleaning could insulate that area from the temperature thus allowing some organisms to survive and so contaminate any subsequent product being processed (Mainpress 2009). This has been highlighted in a study done by Lagrange, et al. (2004).

## Chemicals Used in SIP

SIP is normally achieved by introducing a sanitiser or disinfectant chemical into the final rinse water of the CIP. The common chemical sanitisers are chlorine compound (such as chlorine dioxide), sodium hypochlorite (normally applied at concentrations ranging from 55 – 200 ppm for periods of only a couple of minutes) (Harper & Seiberling 1999), ozone, hydrogen peroxide and peroxyacetic acid (Sutton 2008). The most commonly used sanitizer is a chlorine based product which contains sodium hypochlorite. The use of this product, like caustic soda, adds sodium to the waste water stream and has a potential detrimental impact on waste water reuse options.

Chemical sanitizers should ideally meet the following criteria (Palmowski 2005):

- Be approved for contact surface application
- Have a wide range of scope of activity
- Destroy microorganism activity
- Be stable under all types of conditions
- Be tolerant of a broad range of environment conditions
- Be readily solubilised and posses some detergency
- Be low in toxicity and corrosivity
- Be inexpensive

Single sanitisers may not be able to meet all of these criteria. Therefore it is essential that the properties, advantages and disadvantages of a sanitizer are evaluated for a specific application (Palmowski 2005). The following are case studies of chemical sanitizers for different applications.

- The Effectiveness of different types of sanitizers on reducing the number of viable bacteria attached to stainless steel surfaces has been investigated on a laboratory scale by Dufour et al. (2004). The different types of sanitizers used in this research were chlorine and other alternative sanitizers, i.e. Nisin (a natural antimicrobial agent), Lauricidin (a natural microbial product) and lactoperoxidase system (LPS) (enzyme-based). They exposed the stainless steel surfaces to different combination of sanitizers at different concentration for different lengths of time.

It was found that a greater reduction in the number of bacteria was not always achieved as the chemicals concentration increased. Log reductions varied between 0 – 2. They also reported that after 10 min treatment, none of the sanitizers greatly reduced the number of attached bacteria. While, after 2 hr exposure, there was significant reduction of the bacteria counts on the stainless steel surfaces (Dufour et al. 2004).

- Another study carried out by Langsrud et al. (2000) examined the effects of peroxygen has on *Bacillus cereus* spores and investigated whether alkali treatment sensitised spores to the effect of peroxygen. The cleaning agents tested in this study were sodium hydroxide (NaOH), Paradigm enzyme 10/30 and 2 types of peroxygen based sanitizers, i.e. Parades and Oxonia aktiv.



Pre-treatment of spores with 1% NaOH at 60°C made the spores susceptible to even low concentration of Oxonia aktiv. It was found that at 80°C alkali treatment alone reduced spores significantly, while alkali treatment followed by exposure to Oxonia resulted in significant reduction at 40°C. Also, it was found that the pre-exposure to Paradigm potentiated the effect of Parades. It was concluded that at lower concentration and temperature, peroxygen-based sanitizers are efficient if the pores are exposed first to an alkali or enzyme-based cleaner (Langsrud, Daardsen & Sundheim 2004).

- Lagrange et al. (2004) tested the efficiency of ozonated water applied in CIP systems. They concluded that the suitable use of ozonated water for sanitation was only possible after efficient cleaning. It was found that its ability to remove microorganisms within seconds was extinguished in the presence of protein soil (Eco efficiency 2009).

#### Organic Acid Sterilisers as an Alternative to Chlorine Based Sanitizers

Organic sterilisers are becoming more popular as a substitute for the sodium based chlorine sterilisers. These are generally based on peroxyacetic acid with varying concentrations of acetic acid and hydrogen peroxide. These sterilisers work by penetrating the cell wall and cell membrane and oxidizing the H-S and S-S bonds in the cell's enzymes. The microbes are then unable to function and die. Because the cells are destroyed from the inside-out via oxidation, they cannot develop immunity or mutate to counteract this product. Other advantages of these sterilisers are:

- Broad spectrum efficacy (gram+ and gram- organisms and spores)
- Wide temperature range of efficacy
- Effective for pH up to 8
- Acidic solution
- Low corrosivity to stainless steel
- Environmentally friendly decomposition products (acetic acid, water, oxygen)
- Cost effective in comparison to other readily available sanitisers

#### Ozone as an Alternative to Chlorine Sanitizer

Ozone has a promising future as an alternative to chlorine sanitizer. This is due to its ability to oxidize which offers strong antimicrobial properties. It has been proven effective against a broad range of microbial agents, such as fungi, viruses, protozoa, bacterial and fungal spores (Eco efficiency 2009). Ozonated water can replace or at least reduce the amount of chemicals used for cleaning. A recent study concluded that there is 5-log reduction in microbial contamination when ozonated water is exposed to food contact surfaces for 30 seconds. This satisfies the sanitation standard for food product. Furthermore, it is important to ensure that the ozone level is sufficiently high to kill all organisms but not too high so that certain materials in the process water loop may be degraded.

The advantage of ozonated water over chlorine (Table 13) is that it does not leave any residual chemicals. Therefore, rinsing is not required if simple sanitation is the goal (Higgins 2003). Also, without rinsing, this application would save water compared to a chlorine application (Eco Efficiency 2009). Nevertheless, it is essential to carefully control the ozone

residual (Higgins 2003). One of the major drawbacks of using ozone is mainly about the cost. It is true that, generally, capital and maintenance costs for ozone systems are higher than chlorine applications. Yet, the operation cost is cheaper for ozone systems, with the only cost being electricity.

At room temperature in both air and water, ozone will quickly degrade to oxygen, thus it requires to be generated on site immediately prior to application. In addition, care must be exercised so that it is not discharged into ambient air. Another feature of ozone is that its high concentration may cause degradation, especially on surfaces such as rubber. However, in general, plastic and some stainless steels are quite resistant to corrosion by ozone (Eco Efficiency 2009).

Many companies are starting to utilize ozone as part of their sanitation procedures. A company could reduce its CIP sanitation procedure to a two-step process from four, while other companies incorporate ozonated water as a final intervention or as an additional step (Higgins 2003).

Table 13: Advantages and Disadvantages of Different Chemical Sanitizers (Lenntech 2008)

Chemical sanitizers	Advantages	Disadvantages
Chlorine Dioxide	<ul style="list-style-type: none"> <li>High strength disinfection with minimal environmental impact</li> <li>Produces no organic chlorine compounds, with contaminants most frequently found in water, and the compounds eventually formed are largely negligible in terms of sensory or toxicity consideration</li> <li>Suppresses the forming of the volatile haloforms and reduces the generation of non-volatile organic halogen compounds</li> <li>Cheap disinfection agent</li> </ul>	<ul style="list-style-type: none"> <li>Corrosiveness to stainless steels</li> <li>Formation of organochlorides if it not removed properly</li> </ul>
Ozone	<ul style="list-style-type: none"> <li>High oxidation power (improve CIP effectiveness)</li> <li>No taste or odour is associated with its use</li> <li>Generated on-site (no dangerous storage or handling is required)</li> <li>Without chemical residues</li> <li>Disinfects faster than conventional chemicals (saving time and money)</li> <li>Reduces rinse-up time</li> </ul>	<ul style="list-style-type: none"> <li>When there are no organics left to destroy, dissolved ozone will be detectable in water leaving the equipment</li> </ul>

Peroxyacetic acid	More effective sanitizing, including removal of mineral deposits Effectiveness in cold plant operations Tolerance to residual alkaline cleaning solutions Extended shelf life of products such as milk No/low foaming in CIP systems – quicker to turn process around Less water to treat due to no rinse approval	They are corrosive to some metals, such as brass, copper, mild steel and galvanized steel. High temperatures will also accelerate the corrosion rate. Although solutions are virtually odourless, full strength peroxyacetic acid sanitizers have a strong, pungent smell.
Hydrogen Peroxide	Microbial reduction action can be increased by the addition of peracetic action Very effective No chemical residues	Relatively expensive Corrosive (as pure H <sub>2</sub> O <sub>2</sub> )

### Non-Chemical Sanitizers

While it is common to use chemical sanitisers, nowadays it is generally avoided due to increasing costs and environmental awareness (ViscoTec 2009). Also, non-chemical sanitisers can be used to reduce staff exposure to chemicals (Eco Efficiency 2009). The following are the non-chemical sanitisers.

#### 1. Steam/Dry Heat/Hot Water

Sterilisation process which utilises steam/dry heat/hot water is generally called thermal sterilisation. This is done by application of any of those utilities at an optimum temperature for a suitable time. It has the advantage of affecting areas, such as sample points, which may not be treated by chemical means (Sutton 2008). Currently, SIP using saturated steam is carried out at 125 – 145°C for 10 - 30 minutes (ViscoTec 2009). Furthermore dry and low-pressure steam application is efficient as it has only 5 – 6% moisture and the lower pressures reduce the negative side effect of pressure spread airborne bacteria throughout the plant (Eco Efficiency 2009).

#### 2. Ultraviolet Radiation (UV)

Ultraviolet radiation is able to deactivate microorganism, such as protozoa, bacteria, moulds and yeasts, through interaction with microorganisms' DNA (Palmowski 2005). It is a clean and chemical free process, which effective on different type of contaminants. The advantage of this method is that there is no residual UV radiation to provide an ongoing sanitation compared with chlorine. Therefore, it saves water because it requires no rinsing. On the other hand, UV radiation needs frequent maintenance and replacement of the lamps which can be costly and is not effective in certain applications (Eco Efficiency 2009).

#### 3. Ionisation

This method involves the utilization of an electrode cell to release silver and copper ions into a stream of water. The positively charged silver and copper ions are attracted to the negatively charged surface of the microorganisms, distorting the cells structure and preventing the absorption of nutrients. There has been a trial using this method in one carrot processing plant in Australia. Based on overseas experience, it is expected that ionization will be as effective as chlorine (Palmowski 2005).

#### 4. Electrolysed Oxidizing (EO) Water

This is a new emerging method that has been tested but is still immature. EO water is produced by electrolysis of a weak salt solution into sodium and chlorine, with a membrane between the electrodes to separate the ions from each other, yielding alkaline and acidic EO water. This method has been tested into equipments used in the milk processing industry. The equipment was soaked in the alkaline EO prior to transfer to the acidic EO water. It was found that treatments at 60°C and lower temperatures successfully removed all detectable bacteria. Thus, it can be said that EO water has potential to be used as a disinfecting agent especially in the milk processing industry (Palmowski 2005). However, further research needs to be done before commercialization of this method.

## 1.5 Water and Waste Water

### 1.5.1 What is Trade Waste?

Trade waste is defined by Pagan, R. et al (2004) as any water approved for disposal to sewer that is contaminated by industrial processes. It does not include domestic sewerage.

### 1.5.2 The Impact of Sodium in Trade Waste

Caustic soda or sodium hydroxide (NaOH) is a chemical commonly used for cleaning in the food and beverage industry. Where there is no recovery of the caustic solution following a cleaning sequence, all caustic is discharged to trade waste. This adds a high sodium concentration to the trade waste, which ends up in the sewage treatment plant.

The sewage treatment plant produces treated water or 'recycled' water. This water has a variety of uses; one of the most common is for irrigation. With the current water deficient climate in Australia, use of recycled water for irrigation will become more and more important.

Sodium in waste water is a potential problem as the sewage treatment plants do not remove sodium. Thus, any sodium discharged to trade waste will be present in the final recycled water. If the recycled water is used for irrigation, the sodium can build up in the soil; becoming harmful to plants and negatively affecting their growth, and can also degrade the soil structure.

Minimising the quantity of sodium reporting in waste water is a priority area of the Water Authorities. These guidelines have discussed a variety of mechanisms to reduce sodium levels resulting from CIP processes. In general these include:

- Ensure that the concentrations of sodium based reagents are matched to the duty- vary reagent concentration to reflect the degree of persistence of the deposited soil.
- Recover as much of the sodium based cleaning reagent as possible by including a reagent recovery tank in the CIP set.
- Consider changing cleaning reagents to low sodium or sodium free types. Many alternatives are available and food and beverage businesses should consult their chemical supplier to identify the most appropriate alternative

chemical for the proposed duty. Multi-purpose alternatives often substitute potassium hydroxide (KOH) for sodium hydroxide in varying proportions. While a total substitution is possible from a cleaning effectiveness perspective the additional cost resulting from 100% KOH use usually results in only a partial substitution. These combination products do not reduce the overall salt content of the waste water but they do reduce the sodium content as it is replaced with potassium. The impact of potassium on soil structure and plant growth is generally positive rather than negative.

- Maximise the impact of the various waste streams generated in the factory to minimise the amount of alkali that needs to be added to trade waste to maintain the trade waste pH limits. Where there is an appropriate difference in pH between different waste streams, these can be combined in a neutralisation tank to self-neutralise prior to the addition of alkali for pH adjustment.

As the use of recycled water for land irrigation becomes increasingly important in Australia, the fee charged for disposing of sodium through trade waste will increase.

### 1.5.3 Fit for Use Water

Both definitions of the following 'fit for use' and 'fit for purpose' are used in the same context.

AcquaFit4Use advise: By consuming several billion m<sup>3</sup> of (fresh) water a year, industry has a significant impact on available water sources. Legislation, stringent discharge standards as well as process and product demands, force industries to ensure higher water quality corresponding to increasing costs. For the water consuming industry, water is no longer regarded as a consumable or utility but as a highly valuable asset: a vital element used in close conjunction with the production processes.

Industries want to become more independent of public and private parties for the supply of process water and the treatment of wastewater. Furthermore, they want to use water qualities according to their own specifications, "fit-for-use" (AcquaFitForUse 2009).

Recycled water is defined as water that has been treated to a 'fit for purpose' standard for a specific application. Table 14 illustrates the water classes that can all be used to replace potable water and, if used in an EPA-approved fit-for-purpose application, can be classified as recycled water (Melbourne Water 2009):

Table 14: Potable Water Replacement Water Classes

Class	Range of uses (uses include all lower class uses)
A	Urban (non-potable): with uncontrolled public access Agricultural: e.g. human food crops consumed raw Industrial: open systems with worker exposure potential
B	Agricultural: e.g. dairy cattle grazing Industrial: e.g. wash down water
C	Urban (non-potable) with controlled public access Agricultural: e.g. human food crops cooked/processed, grazing/fodder for livestock Industrial: systems with no potential worker exposure
D	Agricultural: non-food crops including instant turf, woodlots, flowers

#### 1.5.4 The True Cost of Water

Australian manufacturers have often viewed water as a cheap and renewable resource; as a result water has often been taken for granted and been used inadequately in production processes. However, a realisation in the community that water is a precious and finite resource is leading to a shift in the attitudes of Australian manufacturers. Water authorities have adopted a new attitude towards water by focusing on full cost recovery for the supply of fresh water and the treatment of wastewater. The University of Queensland (2004) has investigated in detail the true cost of water while Hatlar has undertaken several resource efficiency studies where the true cost of water has been evaluated for particular companies.

The true monetary value of water is often underestimated in the food and beverage processing industry. In reality water is paid for many times, there are a number of elements which make up the *true cost* of water. The purchase price of water is just one element, in many cases the incoming water must also be pre-treated and heated or cooled to be used in production. Once the water has been utilised in the production process, treatment is also necessary in most cases before the wastewater can be disposed of to trade waste. The water must also be pumped around the factory to be used in the various phases of production which consumes energy and requires maintenance. Capital depreciation of pumps and equipment also holds a monetary value. Each of the processes the water flows through in the operation of the factory equates to a physical expense which emphasises that the cost of water in the production process is often substantially undervalued.

Table 15 illustrates an example of the true cost of water in the food processing industry. The data for this below example has been gathered from The University of Queensland's Eco-Efficiency Toolkit for the Queensland Food Processing Industry (2004) and the South East Water Tariff Schedule (2008)

Table 15: True Cost of Water Example

	\$ / kL
Purchase	\$1.22 <sup>3</sup>
Wastewater Treatment <sup>1</sup>	\$0.75
Wastewater pumping	\$0.05
Wastewater discharge (volume charge)	\$0.56
<b>TRUE COST FOR AMBIENT WATER</b>	<b>\$2.58</b>
Heating to 80°C <sup>2</sup>	\$2.80
<b>TRUE COST FOR HOT WATER</b>	<b>\$5.38</b>

<sup>1</sup> Based on assumption of typical treatment costs for an anaerobic digester

<sup>2</sup> Cost for heating to 80°C using steam produced by a gas boiler

<sup>3</sup> Based on South East Water supply costs

As is evident in the above example the true cost of a kL of water is, in most cases, significantly greater than its purchase price. This provides manufacturers with an incentive to improve their processes to ensure efficient use of water and therefore provide reductions in operational costs.

## 1.6 Human Resources

### 1.6.1 Occupational Health and Safety – CIP systems

When determining the optimum CIP system for a plant a key consideration must be the occupational health and safety (OH&S) of operators. Often, one of the main reasons for upgrading and optimising an existing CIP system is concerns for OH&S.

Manual CIP systems present significant OH&S issues mainly due to the need for an operator to add the often highly corrosive cleaning chemicals by hand. The carrying, lifting, opening and adding of these chemicals can lead to significant risks of chemical exposure and safety concerns. Obvious measures can be taken to reduce the risk to operators such as the use of appropriate PPE, adequate safety training for operators, appropriate chemical storage containers, and safe and reliable chemical adding mechanisms.

Further improvements in chemical safety when operating a manual CIP system can be achieved through changing to less dangerous cleaning chemicals. Considering the use of safer biodegradable chemicals such as organic acids acetic and citric acid instead of using inorganic acids may reduce risks (The University of Queensland 2004). Peroxyacetic acid can be used as an alternative sanitiser to chlorine. Enzyme based cleaners could be used in conjunction with detergents on cold surfaces to reduce the need for caustic based cleaners which can be harmful to operators. Murray Goulburn in Maffra has adopted this enzyme approach (The University of Queensland 2004).

Concerns about occupational health and safety has been the focus of several large company CIP reviews. The CIP systems often required operators to manually lift, manoeuvre and fit the heavy swing bend hoses to set-up the equipment in preparation of each cleaning cycle. This presented a number of OH&S concerns as well as increasing labour and time

requirements. This has been overcome by removing the swing bends and automating the CIP system reducing the need for any heavy lifting by operators.

Manual CIP systems also present other OH&S risks due to the handling of hot water and steam and the manual valve adjustment. This presents risks for scalding and burning as well as strains due to the manual operation. The implementation of an automated CIP system greatly reduces the OH&S issues discussed above.

Automated CIP systems allow the cleaning of equipment, tanks and pipes through an automated system which saves labour and eliminates any human contact with chemicals and hot zones (UniQuest 2008). The reduction or elimination of human chemical handling should be the primary concern in terms of OH&S when optimising a CIP system.

Although the implementation of an automated CIP system dramatically reduces the chemical exposure risks and other safety concerns associated in the cleaning process, greater improvements in the safety of operators can be achieved through optimising existing CIP systems and determining the most appropriate design for the specific factory. Many automated CIP systems still present some OH&S related issues due to tripping or slipping hazards, CIP location and unrepaired equipment (UniQuest 2008).

Existing CIP system OH&S issues can often be addressed through alterations in system design, as was the case with Fosters. Considering potential OH&S issues when determining the best location for an automated or manual CIP system can also help to avoid any tripping or other hazards, the system should be located in an area that is not in or near a frequently used walk-way or door. The area around the CIP system should also be kept clear of any potential tripping hazards and the flooring should be kept dry to avoid slipping. Malfunctioning equipment needs to be repaired promptly and the CIP system will require regular monitoring and audits to ensure that it is in line with safety standards and that any potential OH&S issues are identified before an incident occurs.

### **1.6.2 CIP System and Adequate Training**

Training is a vital element in factory operations, particularly in the food and beverage processing industry. Operator training should be seen as a crucial factor in maintaining high standards in product quality, plant efficiency and safety. Ongoing training of operators helps to establish a habit of best practice and creates a culture of awareness, improvement and expertise.

It is essential that the operators of the CIP system are knowledgeable in all aspects of the CIP operations including understanding why the cleaning process is necessary, how the CIP process operates, chemical awareness, and safety protocols. There are 4 key elements which CIP operators should be trained in to ensure sufficient understanding of procedures. These have been well summarised in two documents, 'Food and Related Product Processing: Clean-in-place food or related product production equipment using automated cleaning systems' and 'Describe cleaning systems and analyse data to optimise CIP performance in dairy manufacturing', produced by the New Zealand Qualifications Authority in 2009.



#### Element 1 – OH&S

Operators must be trained in the importance of safe work practices to ensure that PPE is used in accordance with safety procedures, the work environment is clean and free of hazards, and that any incidents or issues are reported on in accordance with company procedures.

CIP operators should also be aware of the chemistry, dangers and applications of the cleaning chemicals which they are handling to ensure they are aware of the exposure risks and that the chemicals are being used in the correct quantities and for the right purpose.

#### Element 2 – CIP General

CIP operators and other relevant factory personal should be aware of the functions of their CIP system, its components, chemical concentrations, heating requirements, and operational aspects such as processes, cleaning cycles, and cleaning times.

#### Element 3 – Preparing to operate a manual or automated CIP system

Operators must be trained in and adhere to the correct organisational standard operating procedures that are in place in preparation to operate the CIP system. Each step in the preparation to operate the CIP should be clearly indicated such as ensuring the correct cleaning solution is available for the scheduled clean, ensuring the correct concentrations, ensuring the system is configured correctly, and ensuring the production equipment is prepared for cleaning.

#### Element 4 – Operating a manual or automated CIP system

Operators must be trained in and adhere to the correct organisational standard operating procedure that is in place to operate the CIP system. This should include elements such as physical operation procedures, product downtimes, cleaning solution strength, flow and temperature requirements, and post cleaning procedures such as reassembly of production equipment.

It is best practise for a Sanitation Manual outlining all CIP procedures to be developed by the organisation and used as the basis for staff training. This manual will help to ensure operators are sufficiently trained, create an environment for continual improvement, ensure a consistent clean and communicate the policy of the organisation to all employees and contractors. This manual should be continuously updated in accordance with any improvements in operations and procedures which may evolve overtime. The organisation must monitor the CIP system to verify that the standard operating procedures are still the best way to manage the process. Leading organisations conduct a CIP validation and review once per year to assess the efficiency of the CIP cycle and determine whether any improvements can be implemented.

Kraft Foods (Kraft) has developed a Global Sanitation Manual which outlines many aspects of the operation of their CIP system including the minimum conditions that must be met during a clean such as temperature, reagent concentration, flow rate, and time; CIP operation

protocols; CIP verification and monitoring; documentation requirements; frequency of verification and validation.

Kraft also places great importance on operator training. Kraft CIP operators receive regular training in relation to CIP including HACCP training, allergen awareness training, chemical training, and additional training by the Kraft Global Sanitation Group. Kraft has been able to use its Sanitation Manual and ongoing training systems to ensure that operators develop a habit of best practise and are consistent in operations.

## References

- AquaFitForUse, 2009, *Facts and Figures*, Uniresearch, viewed 10 September 2009, <<http://www.aquafit4use.eu/index.php>>
- Australian Food Safety Centre of Excellence, 2007, *Cleaning and Sanitizing Factsheet*, Australian Government Department of Agriculture Fisheries and Forestry, <<http://www.foodscience.afisc.csiro.au/factsheets/sanitation-factsheet.pdf>>
- Bishop, A., 1997, 'Wesmar Company Inc', "*Basic Principles of Sanitation" Cleaning In The Food Industry*, presented by N.E.M Business Solutions who have been granted permission by Wesmar Company. Available online from: <http://www.cip.ukcentre.com/clean.htm> [Accessed 12 February 2009]
- Canut, A. Pascual, A., 2007, Research Association on Food Industry (ainia). Quality, food safety and environment department. *OzoneCip: Ozone Cleaning in Place in Food Industries*. Available from: <http://ec.europa.eu/environment/life/project/Projects/index.cfm?fuseaction=home.showFile&rep=article&fil=OZONECIP-Art1-OzoneCipOzoneCleaning-FoodIndustries.pdf> [Accessed 12 February 2009]
- City West Water Limited, 2009, Resource Efficiency Co-Funding Case Study, *Tollman take their water and energy savings to a new level*
- Community College of Rhode Island, 2009, *Total Dissolved Solids*, CCRI, viewed 29 October 2009, <<http://74.125.153.132/search?q=cache:a5VipgAQf6QJ:faculty.ccri.edu/sqorelick/Test%252012%2520TDS.doc+TDS+measure+evaporation&cd=1&hl=en&ct=clnk>>
- Dairy Industries Sustainability Consortium, 2004, *A holistic approach to the management of dairy processor waste streams, CIP chemicals and practices to reduce Sodium in dairy processor waste streams*, <http://diaa.asn.au/imagebank/Doc/Closing%20the%20Loop/Technical%20Reports/CIP/2005%20Review%20products%20&%20processes%20to%20reduce%20sodium%20usage.pdf>
- Dairy Safe, 2006, *CIP (Cleaning In Place) Systems*, Dairy Food Safety Victoria, viewed 8 September 2009, <[http://www.dairysafe.vic.gov.au/pdf/DFSNote5\\_CleaningInPlaceSystems\\_6Nov2006.pdf](http://www.dairysafe.vic.gov.au/pdf/DFSNote5_CleaningInPlaceSystems_6Nov2006.pdf)>
- Deakin University, 2008, *Smart Water Fund Industrial Cleaning Practises – Final Report 23/10/06 – 14/11/08 Draft Copy*
- Deakin University, 2005, *Clean in Place – A Review of Current Technology and its Use in the Food and Beverage Industry*, Report for General circulation
- Dufour, M, Simmonds, R, & Bremer, P, 2004, *Development of laboratory scale clean-in-place system to test the effectiveness of "natural" antimicrobials against dairy biofilms*, IngentaConnect, Journal of Food Protection 67(7) pp.1438-1443, viewed 11 September 2009, <<http://www.ingentaconnect.com>>
- Eco-Efficiency, 2009, *Clean In Place Systems – W5 – Improve CIP System Efficiency, Eco-Efficiency for Queensland Manufacturers Pathway to Sustainability*, viewed 9 September 2009,

<[http://www.ecoefficiency.com.au/Portals/56/factsheets/foodprocess/water/ecofoodwater\\_fsw5.pdf](http://www.ecoefficiency.com.au/Portals/56/factsheets/foodprocess/water/ecofoodwater_fsw5.pdf)>

Eco-Efficiency, 2009, *Cleaning and Sanitation Options – W6 – Alternative to Traditional Practices*, Eco-Efficiency for Queensland Manufacturers Pathway to Sustainability, viewed 9 September 2009, <[http://www.ecoefficiency.com.au/Portals/56/factsheets/foodprocess/water/ecofoodwater\\_fsw6.pdf](http://www.ecoefficiency.com.au/Portals/56/factsheets/foodprocess/water/ecofoodwater_fsw6.pdf)>

Edstorm, 2009, *Dead Legs*, Edstorm Industries Inc., viewed 9 September 2009, <[http://www.edstrom.com/Resources.cfm?doc\\_id=139](http://www.edstrom.com/Resources.cfm?doc_id=139)>

Endress+Hauser GmbH +Co. KG., *Competence in conductivity measurement*, available online from: <http://www.endress.com> [Accessed on 3 February 2009]

Endress+Hauser GmbH +Co. KG., Brewing Industry, *Analytical Measurement Solutions for Optimization of your Brewing Process*, available online from: [www.mt.com/pro](http://www.mt.com/pro) [Accessed 3 February 2009]

Endress & Hauser Inc, 2009, *CIP System – Clean-In-Place (CIP) is used in Many Operations to Maintain Sanitary Conditions in Processes*, Endress, viewed 1 September 2009, <<https://wa001.endress.com/dla/50000015753/000/00/CS0606.pdf> >

Envirowise, 2002, *Water Minimisation in the Food and Drink Industry* [Online]. Available from: <http://www.envirowise.gov.uk/uk/Sectors/Food-and-drink/GG349-Water-Minimisation-in-the-Food-and-Drink-Industry.html> [Accessed 12th May 2009]

Envirowise, 2008, *Reducing Water use Through Cleaning-in-Place (CIP)* [Online]. Available from: <http://www.envirowise.gov.uk/uk/Our-Services/Publications/EN894-Reducing-water-use-through-cleaning-in-place-CIP.html> [Accessed: 12th May 2009]

Envirowise, 2009, *Water minimization in the food and drink industry*, Envirowise: <[http://www.envirowise.gov.uk/food\\_drink/water\\_minimisation](http://www.envirowise.gov.uk/food_drink/water_minimisation)>

Essential Services Commission, 2008, *OTH SEW 200809 Tariff Schedule 20080724*, Essential Services Commission, viewed 26 August 2009, < <http://www.esc.vic.gov.au/NR/rdonlyres/FC9C27AA-A456-45DB-97DD-C19447E2139A/0/OTHSEW200809Tariffschedule20080724.pdf>>

European IPPC Bureau, 2006, *Integrated Pollution Prevention and Control -Reference document on Best Available Techniques in the Food, Drink and Milk Industries (Cleaning Section)*, viewed 8 August 2009, <[http://www.bvt.umweltbundesamt.de/archiv-e/fdm\\_bref\\_1205\\_summary.pdf](http://www.bvt.umweltbundesamt.de/archiv-e/fdm_bref_1205_summary.pdf)>

FMC Corporation, VigorOx®  
<http://www.fmcchemicals.com/Products/PeraceticAcid/FoodSafetyProductUsage.aspx> [viewed 12 January 2010]

Food Hygiene Australia (2009) *The HACCP Seven Principles* [Online]. Available from: <http://www.foodhygieneaustralia.com.au/> [Accessed 10<sup>th</sup> September 2009]

Forder, S & Hyde, J, 2005, *Increasing Plant Efficiency through CIP*, BioPharm International, viewed 8 September 2009, <<http://biopharminternational.findpharma.com/biopharm/article/articleDetail.jsp?id=146346&sk=&date=&pageID=3>>

Foster's Group (2007) *Abbotsford Brewery Water Usage Facts Jan 07* [Online] [http://www.fosters.com.au/about/docs/Abbotsford\\_Fact\\_Sheet.pdf](http://www.fosters.com.au/about/docs/Abbotsford_Fact_Sheet.pdf) [Accessed 28th July 2009]

GEA Process Engineering Inc. (2009) *Caustic recovery using membrane filtration* [Online]. Available from: [http://www.geafiltration.com/filtration\\_library/caustic\\_recovery\\_membrane\\_filtration.pdf](http://www.geafiltration.com/filtration_library/caustic_recovery_membrane_filtration.pdf) [Accessed 7th September 2009].

Gruszczynski, D. W., Margevich, D. E., & Fornalik, M. 2004, *Clean-in-place Method for Cleaning Solution Delivery Systems/Lines*, United States Patent 6679274.

Hammond, J., 'Presented by N.E.M Business Solutions', *Microbiological Techniques to confirm CIP effectiveness*, available online from: <http://www.cip.ukcentre.com/confirm.htm> [Accessed 3 February 2009]

Harper, W & Seiberling, D, 1999, *Typical Cleaning Program and Procedure*, viewed 8 September 2009, <<http://www.seiberling4cip.com/prg&proc.htm>>

Higgins, K, 2003, *Tech Update: Clean-in-Place Continues to Evolve*, *Food Engineering Magazine*, viewed 9 September 2009, <[http://www.foodengineeringmag.com/Articles/Feature\\_Article/23f45103942f8010VqnVCM100000f932a8c0](http://www.foodengineeringmag.com/Articles/Feature_Article/23f45103942f8010VqnVCM100000f932a8c0)>

Hyde, M, Walter, P & Bader, K, 2007, *PAT for Pharmaceutical Cleaning*, *Control Engineering*, viewed 8 September 2009, <[http://www.controleng.com/article/275024-PAT\\_for\\_Pharmaceutical\\_Cleaning.php](http://www.controleng.com/article/275024-PAT_for_Pharmaceutical_Cleaning.php)>

Jeffery, N. Sutton, E. 2008, *Design for CIP*, [Online]. Suncome CIP & Process Engineers, Available from: <http://www.suncombe.com/pdfs/CIP%20Overview.pdf> [Accessed 11<sup>th</sup> May 2009]

JJC Engineering Pty Ltd, 2008, *Process Integration Study Investigations into Water Use, Salt Discharge and Energy Reductions in the Meat Processing and Rendering Sector*. City West Water, Melbourne. Labs, W 2007, 'Tech Update: Clean-in-place systems benefit from automation', available online from: [http://www.foodengineeringmag.com/Articles/Feature\\_Article/BNP\\_GUID\\_9-5-2006\\_A\\_1000000000000046112](http://www.foodengineeringmag.com/Articles/Feature_Article/BNP_GUID_9-5-2006_A_1000000000000046112) [Accessed 3 February 2009]

John Diversey, 2009, *DIVOSHEEN DILAC*, JohnDiversey Inc., viewed 29 October 2009, <http://www.johnsondiversey.com/Cultures/en-AU/OpCo/Products+and+Systems/Products/Divosheen+Dilac.htm>

Kim, Y., Lee, K., & Chung, J., 2002, 'Optimum Cleaning-in-place Conditions for Stainless Steel Microfiltration Membrane Fouled by Terephthalic Acid Solids' *Journal of Membrane Science*, vol. 2009, no.1, pp. 233-240.

Langsrud, S, Baardsen & Sundheim, G, 2000, *Potential of the lethal effect of peroxygen on Bacillus cereus spores by alkali and enzyme wash*, International Journal of Food Microbiology, 56 pp 81-88, ScienceDirect, viewed on 11 September 2009, <<http://www.sciencedirect.com>>

Lenntech, 2008, *Disinfection with CIP*, Lenntech Water Treatment and Air Purification, viewed 9 September 2009, <http://www.lenntech.com/CIP-disinfection.htm>

Mainpress, 2009, 'Clean' What does It mean? An Attempt to Clarify the Terms Used, viewed 9 September 2009, [http://www.mainpress.com/nederlands/dossier\\_pompen/CLEAN.htm](http://www.mainpress.com/nederlands/dossier_pompen/CLEAN.htm)

Masson, L., Northern Territory Chamber of Commerce and Industry Inc., *Utilisation of a Fully Automated Cleaning System in a Milk Plant*, available online from: <http://p2pays.org/ref/04/03618/> [Accessed on 3 February 2009]

McPhail, N., 2006, *Review of Water Recycling/Reuse in the Meat Industry*, JJC Engineering Pty Ltd and Food Science Australia.

Melbourne Water, 2002, *Links and FAQs – How is Recycled Water Defined?*, EPA Victoria, viewed 10 September 2009, <[http://www.melbournewater.com.au/content/water\\_recycling/links\\_and\\_faqs/links\\_and\\_faqs.asp?bhcp=1](http://www.melbournewater.com.au/content/water_recycling/links_and_faqs/links_and_faqs.asp?bhcp=1)>

Melrose Chemicals, 2008, *Alka Clean Additive – A Revolutionary Additive to CIP Cleaners*, Melrose Chemicals, viewed 8 September 2009, <<http://www.melrosechem.com/english/publicat/dairy%20industries/alkaclean.pdf>>

Melrose Chemicals Ltd, 2009, *CIP Cleaning*, viewed 8 September 2009, <<http://www.melrosechem.com/english/publicat/dairy%20industries/cip.pdf>>

Mettler Toledo, Dairy News, *Perspectives in Liquid Process Analytics*, available online from: [www.mtpro.com](http://www.mtpro.com) [Accessed 3 February 2009]

Miller, R, 1999, *Aquatic Plants - Measuring Water Flow*, viewed 1 September 2009, <<http://fins.actwin.com/aquatic-plants/month.9911/msg00294.html>>

Moralee, N., 1999, 'N.E.M Business Solutions', *C.I.P sets their makeup and maintenance*, available online from: <http://www.cip.ukcentre.com/cipmaint.htm> [Accessed 3 February 2009]

N.E.M Business Solutions, C.I.P in the "Ready Meals Industry", available online from: <http://www.cip.ukcentre.com/meals1.htm> [Accessed 12 February 2009]

N.E.M Business Solutions, 1997, *Cleaning in the Food Industry*, UK Centre, viewed 8 September 2009, <<http://www.cip.ukcentre.com/clean.htm>>

NEM Business Solutions, 2002, *Spray Ball Designs*, NEM Business Solutions, viewed 9 September 2009, <<http://www.cip.ukcentre.com/sball.htm>>

Nidomac Co Ltd (2001) *Sterisan Material Data Sheet*. Available from: <http://www.nidomac.com/sterisan.htm> [Accessed: 30th of July 2009].

NIRO POWDER TECHNOLOGY, 2009, *Cleaning-in-Place of Spray Drying Plants*, [http://www.niroinc.com/html/chemical/cpdfs/cleaning\\_in\\_place\\_spray\\_drying\\_plants.pdf](http://www.niroinc.com/html/chemical/cpdfs/cleaning_in_place_spray_drying_plants.pdf)

Omega Engineering, 2009, *Introductions to Flow Meter*, Omega Engineering Technical Reference, viewed 1 September 2009, <<http://www.omega.com/prodinfo/flowmeters.html>>

New Zealand Qualifications Authority, 2009, *Food and Related Product Processing – Cleaning: Clean-in-place food or related product production equipment using automated cleaning systems*, viewed 24 August 2009, <http://www.nzqa.govt.nz/nqfdocs/units/pdf/7681.pdf>

New Zealand Qualifications Authority, 2009, *Describe cleaning systems and analyse data to optimise CIP performance in dairy manufacturing*, version 2, viewed 24 August 2009, <<http://www.nzqa.govt.nz/nqfdocs/units/pdf/21126.pdf>>

Oregon State University, 1994, *Estimating Water Flow Rates*, Oregon State University Extension Service, viewed 1 September 2009, <<http://extension.oregonstate.edu/catalog/pdf/ec/ec1369.pdf>>

Omega Engineering, 2009, *Introductions to Flow Meter*, Omega Engineering Technical Reference, viewed 1 September 2009, <<http://www.omega.com/prodinfo/flowmeters.html>>

Pagan, R. Prasad, P. Price, N. and Kemp, E., 2004, *Eco-efficiency Toolkit for the Queensland Food Processing Industry*, [Online]. The UNEP Working Group for Cleaner Production in the Food Industry, Available from: [http://www.gpem.uq.edu.au/CleanProd/food\\_project/Food%20manual.pdf](http://www.gpem.uq.edu.au/CleanProd/food_project/Food%20manual.pdf) [Accessed 4 May 2009]

Pagcatipunan, C. 2008. *A Guide to Tank Cleaning Automation*, Spraying Systems Co, Wheaton, IL, USA [Online]. Available from: [http://service.spray.com/web/register/view\\_lit.asp?code=B526B](http://service.spray.com/web/register/view_lit.asp?code=B526B) [Accessed 9<sup>th</sup> June 2009]

Palmowski, L, et al, 2005, *Clean in Place – A Review of Current Technology and Its Use in the Food and Beverage Industry*, Deakin University

Patterson, R.A. 2000. Wastewater Quality Relationships with Reuse Options in *Proceedings of 1<sup>st</sup> World Water Congress of the International Water Association*, 3-7 July 2000. Paris, France. Conference Preprint Book 8, pp 205-212.

Pharma Manufacturing., 2004 – 2009, *Conductivity Measurement: Critical for Clean-In-Place Systems*, available online from: <http://www.pharmamanufacturing.com/articles/2007/159.html>

[Accessed 3 February 2009]

Priest, F, & Campbell, I, 2003, *Brewing Microbiology*, 3rd Ed, Google Books, viewed 2 September 2009,

<[http://books.google.com/books?id=jafz6LhdUeC&printsec=frontcover&source=gbs\\_v2\\_summary\\_r&cad=0#v=onepage&q=&f=false](http://books.google.com/books?id=jafz6LhdUeC&printsec=frontcover&source=gbs_v2_summary_r&cad=0#v=onepage&q=&f=false)>

Queensland Water Commission (2007) *Water Use in the Food Processing Industry*. Available from: [http://www.gwc.qld.gov.au/myfiles/uploads/wemp/Food\\_processing\\_151106.pdf](http://www.gwc.qld.gov.au/myfiles/uploads/wemp/Food_processing_151106.pdf) [Accessed 10th September 2009].

Rosemount Analytical Inc, 2006, Emerson Process Management., 'Food & Beverage Industry Solutions, *Accurate and Reliable Liquid Analysis*, available online from: [www.railhome.com](http://www.railhome.com) [Accessed 3 February 2009]

Rushing, J. E., Ward, D. R. (2009) *HACCP Principles* [Online]. Available from: <http://www.ces.ncsu.edu/depts/foodsci/ext/pubs/haccpprinciples.html> [Accessed 17th July 2009]

Showell, S, 2005, *Handbook of Detergents*, Google Books, <[http://books.google.com.au/books?id=yMtDOXqm15IC&pg=PA275&lpg=PA275&dq=surfactants+detergents+in+CIP&source=bl&ots=8JzQL9k6yc&sig=jETKUcwo8sSHJmV3i3kivqeNdR0&hl=en&ei=vxymSt6HMYOJKQWoleiLCO&sa=X&oi=book\\_result&ct=result&resnum=10#v=onepage&q=surfactants%20detergents%20in%20CIP&f=false](http://books.google.com.au/books?id=yMtDOXqm15IC&pg=PA275&lpg=PA275&dq=surfactants+detergents+in+CIP&source=bl&ots=8JzQL9k6yc&sig=jETKUcwo8sSHJmV3i3kivqeNdR0&hl=en&ei=vxymSt6HMYOJKQWoleiLCO&sa=X&oi=book_result&ct=result&resnum=10#v=onepage&q=surfactants%20detergents%20in%20CIP&f=false)>

Spraying Systems Co., 2008. *Change the Way You Spray to Maximize Water Conservation*. Spraying Systems Co, Wheaton, IL, USA . Available from: [http://service.spray.com/web/register/view\\_lit.asp?code=TM415](http://service.spray.com/web/register/view_lit.asp?code=TM415) [Accessed 9<sup>th</sup> June 2009]

Sutton, J, 2008, *Design for CIP*, Suncombe CIP & Process Engineers, viewed 8 September 2009, <<http://www.suncombe.com/pdfs/CIP%20Overview.pdf>>

The Engineering Toolbox, 2005, *Types of Fluid Flow Meter*, viewed 1 September 2009, <[http://www.engineeringtoolbox.com/flow-meters-d\\_493.html](http://www.engineeringtoolbox.com/flow-meters-d_493.html)>

The Engineering Toolbox, 2005, *System Curve and Pump Performance Curve*, viewed 3 September 2009, <[http://www.engineeringtoolbox.com/pump-system-curves-d\\_635.html](http://www.engineeringtoolbox.com/pump-system-curves-d_635.html)>

The European Commission, 2006, *Integrated Pollution prevention and Control Reference Document on Best Available Techniques in the Food, Drink and Milk Industries*, The European IPPC Bureau. Available from: [http://ftp.jrc.es/eippcb/doc/fdm\\_bref\\_0806.pdf](http://ftp.jrc.es/eippcb/doc/fdm_bref_0806.pdf) [Accessed 4 May 2009].

The University of Queensland, 2004, *Eco-efficiency for Australian dairy processors; Fact sheet 9: Chemical use*, Dairy Australia, viewed 26 August 2009, <[http://www.qpem.uq.edu.au/CleanProd/dairy\\_project/Fact%20Sheet%209%20\(4\).pdf](http://www.qpem.uq.edu.au/CleanProd/dairy_project/Fact%20Sheet%209%20(4).pdf)>



UniQuest, 2008, *Clean-In-Place Systems – W5; Improve CIP System Efficiency*, University of Queensland, viewed 24 August 2009, <[http://www.ecoefficiency.com.au/Portals/56/factsheets/foodprocess/water/ecofoodwater\\_fsw5.pdf](http://www.ecoefficiency.com.au/Portals/56/factsheets/foodprocess/water/ecofoodwater_fsw5.pdf)>

ViscoTec, 2009, *CIP-/SIP- Cleaning*, ViscoTec, viewed 9 September 2009, <<http://www.viscotec-usa.com/content/index.cfm/fuseaction/98,dsp,0,1,0,0,0,0,-Food%20-%20Pharma%20-%20CIP--SIP%20Cleaning.html>>

Voss, J, 1996, *Cleaning and Cleaning Validation: A Biotechnology Perspective*, Interpharm CRC, viewed 9 September 2009, <[http://books.google.com.au/books?id=IMVI8dJ9wDkC&pg=PA9&lpg=PA9&dq=why+do+dead+legs+exist+in+CIP&source=bl&ots=gzflurJNbC&sig=ijBrCbfc2BDc6eN7ir174FKDQpQ&hl=en&ei=uG0mSraUL5fs6APi7uiZBg&sa=X&oi=book\\_result&ct=result&resnum=3#v=onepage&q=&f=false](http://books.google.com.au/books?id=IMVI8dJ9wDkC&pg=PA9&lpg=PA9&dq=why+do+dead+legs+exist+in+CIP&source=bl&ots=gzflurJNbC&sig=ijBrCbfc2BDc6eN7ir174FKDQpQ&hl=en&ei=uG0mSraUL5fs6APi7uiZBg&sa=X&oi=book_result&ct=result&resnum=3#v=onepage&q=&f=false)>

Watson, J, 2004, *Use of Acid-Blend Detergents and the Avoidance of Foam*, ISPE Engineering Pharmaceutical Innovation, viewed 8 September 2009 <[http://www.ispeboston.org/technical\\_articles/boston\\_area\\_use\\_of\\_acidblend\\_detergents\\_and\\_the\\_avoidance\\_of\\_foam.html](http://www.ispeboston.org/technical_articles/boston_area_use_of_acidblend_detergents_and_the_avoidance_of_foam.html)>

Weeks, M. (2007) *Closing the Loop*, Department of Primary Industries, Melbourne